

Power Measurement Basics



Abstract

In this presentation you will learn about high-frequency power measurements and how they differ from low-frequency or DC measurements. Definitions and terms involving absolute, ratio and peak power measurements are also covered. You will learn about the differences in various power measurements and situations where each type of measurement is used. Next, some of the hardware and theory behind the major types of power sensors and the power meter is given. Measurement uncertainty is critical and another section covers the uncertainties associated with power measurements, including sensor and source mismatch, sensor errors, and meter errors. An uncertainty calculation example is presented. Finally, the session will address how to match the correct equipment to particular applications.

Power Measurement Basics



Power Measurement Basics



Agilent Technologies

www.agilent.com/find/backtobasics

Slide 1

Welcome to Power Measurement Basics.

Agenda

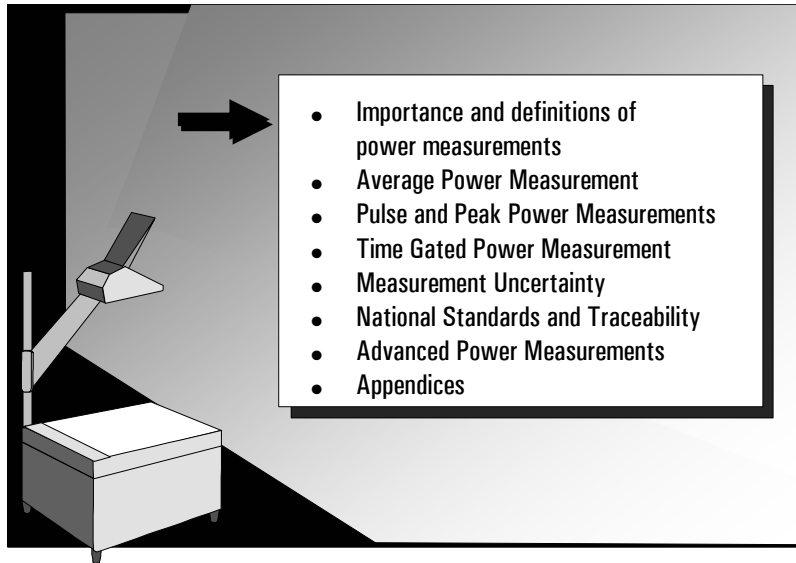

- Importance and definitions of power measurements
- Average Power Measurement
- Pulse and Peak Power Measurements
- Time Gated Power Measurement
- Measurement Uncertainty
- National Standards and Traceability
- Advanced Power Measurements
- Appendices



Importance of Proper Signal Levels

- Too low
– Signal buried in noise

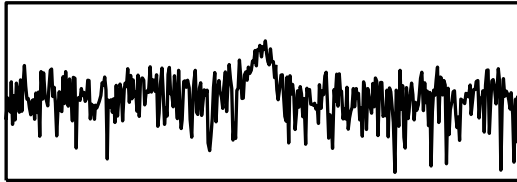

- Too high
– Nonlinear distortion can occur

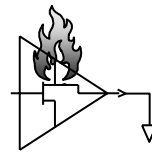
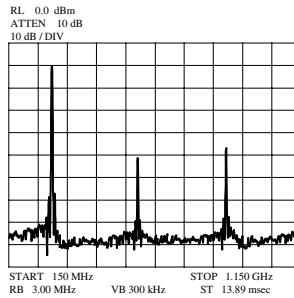

– Or even worse!

Power Measurement Basics



Agilent Technologies

www.agilent.com/find/backtobasics

Slide 3

Why do we measure signal levels? A component or system's output signal level is often the critical factor in the design and ultimately the purchase and performance of almost all RF and microwave equipment.

Measurement of the signal level is critical at every system level, from the overall system performance to the fundamental devices. The large number of signal measurements and their importance to system performance dictates that the measurement equipment and techniques be accurate, repeatable, traceable, and convenient.

In a system, each component in a signal chain must receive the proper signal level from the previous component and pass the proper signal level on to the succeeding component. If the output signal level becomes too low, the signal becomes obscured in noise. If the signal level becomes too high, though, the performance goes nonlinear and distortion results. Or worse!

Why Not Measure Voltage?

- DC

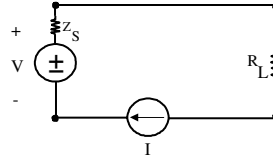

- Low Frequency

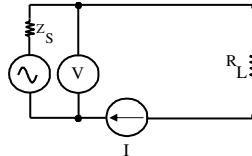

- High Frequency

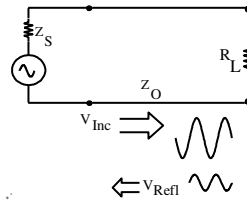

Power Measurement Basics



Agilent Technologies

www.agilent.com/find/backtobasics

Slide 4

At DC and low frequencies, voltage measurements are simple and straight forward. If power is needed, it is easily calculated:

$$P = IV = \frac{V^2}{R} = I^2 R$$

However, as the frequency approaches 1 GHz, direct power measurements become prevalent in most applications because voltage and current measurements become impractical. One reason for this is that voltage and current may vary with position along a lossless transmission line, whereas power maintains a constant value. Another example of decreased usefulness is in waveguide transmission configurations where voltage and current are more difficult to define. For these reasons, at radio and microwave frequencies, power is more easily measured, easier to understand, and more useful than voltage or current as a fundamental quantity.

Looking at the 'High Frequency' example in the slide, for maximum power transfer, the load R_L should be equal to the source output impedance Z_S . In practical applications this is not achievable and some portion of the incident signal (V_{Inc}) is reflected from the load to the source (V_{Refl}). When two travelling waves are present, and are travelling in opposite directions, this gives rise to so-called standing waves. The envelope of the standing wave does not change with time but remains stationary, thus the term 'standing wave'. The ratio of the maximum value (maxima) to the minimum value (minima) of the envelope is a measure of the relative amounts of oppositely travelling waves. A useful figure of merit often employed in transmission theory and practice is the 'voltage standing wave ratio' abbreviated VSWR. It is defined as the ratio of the absolute value of the maximum to the minimum value of the envelope. We will be discussing VSWR in more detail in this presentation in the Measurement Uncertainty section.

$$\text{Power: } P = (I)(V)$$

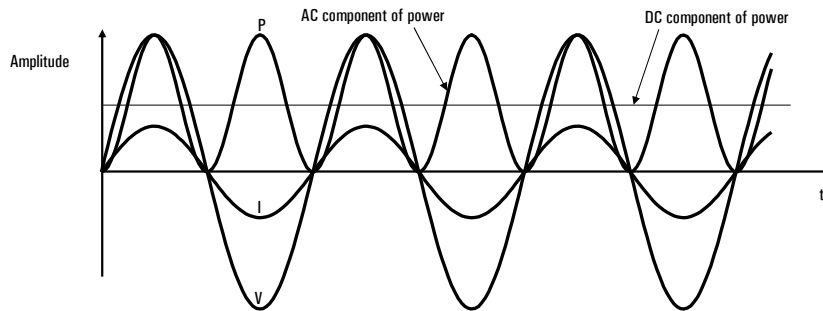
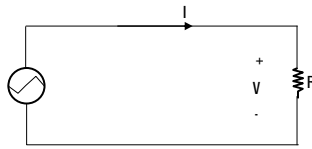

Power Measurement Basics



Agilent Technologies

www.agilent.com/find/backtobasics

Slide 5

First, let's make sure we understand what is meant when talking about power. General circuit theory says that for an arbitrary load, power is the product of voltage, current, and the power factor (where power factor is defined as the cosine of the phase angle between the voltage and current). For a purely resistive load the power factor is one and instantaneous power is simply the product of voltage and current. For an AC signal we see that power is time dependent. This product of voltage and current is sinusoidal with a DC (average) term and has a frequency twice that of the AC signal. "Power", as most commonly used, refers to average power. To find this average, the power curve must be integrated to find the area under the curve and then divided by the length of time over which the area is taken. Note: this length of time should be an exact number of AC periods, but as the number of periods gets higher and higher, whether you measure a precise number of periods or not makes a vanishingly small difference.

Fundamentally, power is defined as the energy transfer per unit time averaged over many periods of the lowest frequency involved.

For sinusoidal signals, the relationship between peak and rms (root-mean-square) values are:

$$V_p = \sqrt{2}V_{rms} \quad I_p = \sqrt{2}I_{rms}$$

and

The rms value for a periodic sinusoidal current (voltage) is defined as the constant that is equal to the DC current (voltage) that would deliver the same average power to a resistance R.

Units and Definitions

$$\text{Power: } P = (I)(V)$$

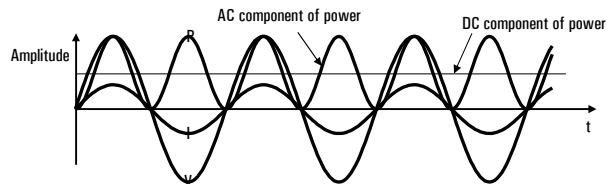

- Unit of power is the watt (W): $1\text{W} = 1 \text{ joule/sec}$
- Some electrical units are derived from the watt:
 $1 \text{ volt} = 1 \text{ watt/ampere}$
- Relative power measurements are expressed in dB:
 $P(\text{dB}) = 10 \log(P/\text{Pref})$
- Absolute power measurements are expressed in dBm:
 $P(\text{dBm}) = 10 \log(P/1 \text{ mW})$

Power Measurement Basics



Agilent Technologies

www.agilent.com/find/backtobasics

Slide 6

Power is defined as the amount of energy flow per unit of time, and the basic unit of power is the watt (W). One watt equals one joule per second. The watt is a basic unit in that other electrical units are derived from the watt. For example, a volt is defined as one watt per ampere.

Decibels ease the problem of expressing power levels that greatly differ from one another. For example the output of a transmitter might be two kilowatts ($2 \times 10^3\text{W}$) while the signal level at a receiver's antenna might be five picowatts ($5 \times 10^{-12}\text{W}$). A more concise notation using decibels, would be +63 dBm at the transmitter and -83 dBm at the antenna.

Another advantage of decibels is apparent when it is necessary to find the gain of several cascaded devices. Multiplication of numeric gain is then replaced by the addition of the power gain in dB of each device

Absolute power is expressed in terms of dB relative to some power level. For example, power relative to 1mW is stated in dBm.

Instruments used to Measure RF and Microwave Power

- Vector Signal Analyzer
- Spectrum Analyzer
- Network Analyzer
- Power Meter and Sensor

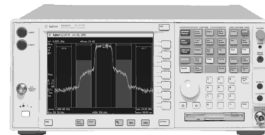

Power Measurement Basics



Agilent Technologies

www.agilent.com/find/backtobasics

Slide 8

Although a variety of instruments measure power, the most accurate instrument is a power meter and a sensor. The sensor is an RF power-to-voltage transducer. The power meter displays the detected voltage as a value of power in log (dBm) or linear (watts) units. Typical power meter instrumentation accuracy will be in the order of hundredths of a dB, while other instruments (i.e., spectrum analyzers, network analyzers) will have power measurement accuracies in the tenths of dBs or more. We will discuss the overall uncertainty of power measurements in more detail later on in this presentation.

One of the main differences between the instruments is that of frequency selective measurements. Frequency selective measurements attempt to determine the power within a specified bandwidth. The traditional Power Meter is not frequency selective in that it measures the average power over the full frequency range of the sensor and will include the power of the carrier as well as any harmonics which may be generated. A Spectrum Analyzer provides a frequency selective measurement since it measures in a particular Resolution Bandwidth.

The lack of frequency selectivity is the main reason that Power Meters measure down to around -70 dBm and instruments such as a spectrum analyzer can measure much lower than this if narrow resolution bandwidths are used.

Agenda

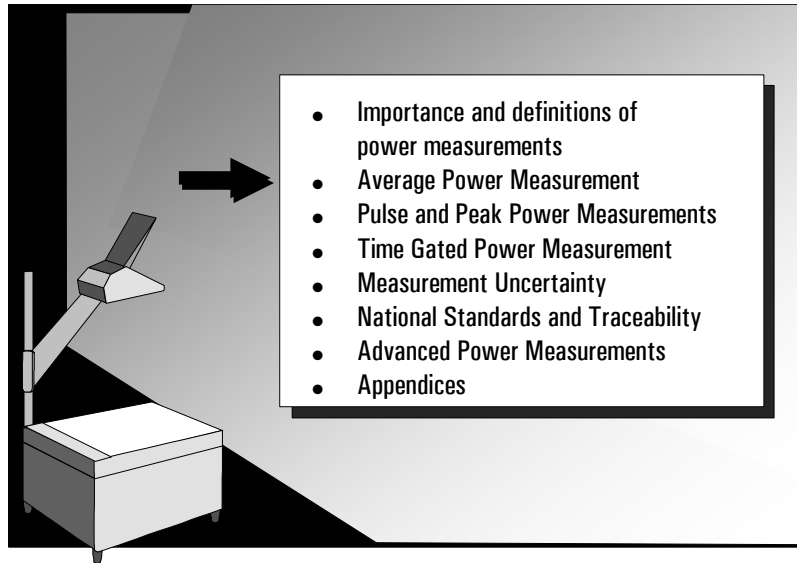

Power Measurement Basics



Agilent Technologies

www.agilent.com/find/backtobasics

Slide 9

Average Power provides the average power delivered over several cycles and this is the most common power measurement performed today.

Average power is defined as the energy transfer rate averaged over many periods of the lowest frequency in the signal. Average power is also defined as the power averaged over a specified time interval.

$$p_{avg}(t) = \frac{1}{T} \int_{-\frac{T}{2}}^{\frac{T}{2}} p(t - \tau) d\tau$$

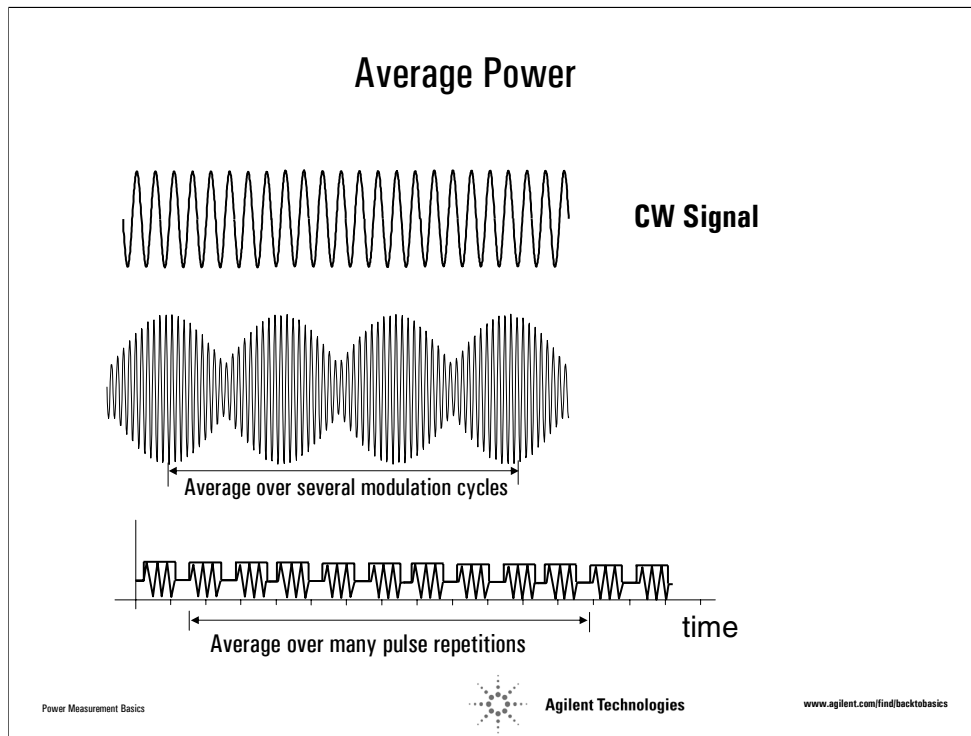

Slide 10

For an AM signal, averaging is taken over many modulation cycles, and for a pulse modulated signal the signal is averaged over several pulse repetitions. Of all the power measurements, average power is the most frequently measured because convenient measurement equipment with highly accurate and traceable specifications is available.

Additional waveform information can sometimes be calculated from average power measurements if certain waveform characteristics are known. If, for example, the duty cycle of a rectangular pulsed signal is known, then peak power can be found from the average power measurement by the equation:

$$P_{peak} = \frac{P_{avg}}{DutyCycle}$$

Note that the peak power here is only applicable for a true rectangular pulse with no overshoot present.

Basic Measurement Method - Using a Power Meter

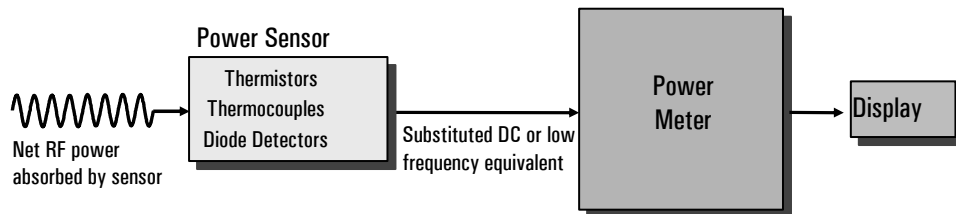

Power Measurement Basics



Agilent Technologies

www.agilent.com/find/backtobasics

Slide 11

Let's now look at the types of hardware, both sensors and meters, that are used in average power measurements.

The basic idea behind a power sensor is to convert high frequency power to a DC or low frequency signal that the power meter can then measure and relate to a certain RF power level. The three main types of sensors are thermistors, thermocouples, and diode detectors. There are benefits and limitations associated with each type of sensor. We will briefly go into the theory of each type and then talk about the advantages and limitations associated with each sensor.

Basic Measurement Method Explained

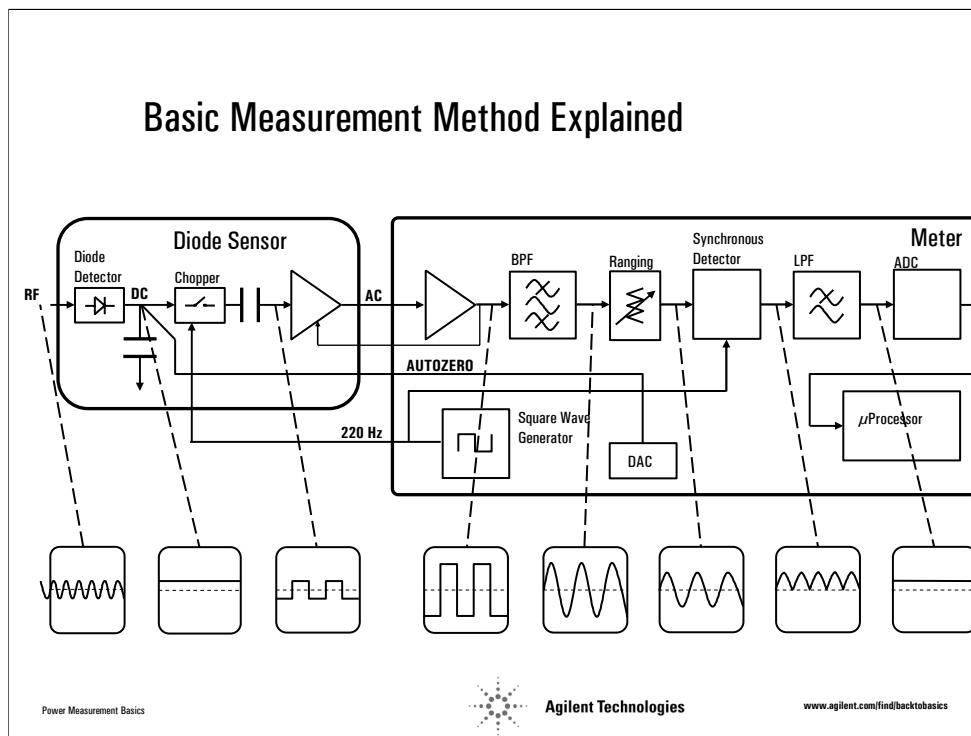

Slide 12

Shown here is the basic power measurements method. Both thermocouple and diode detector mounts generate voltages on the order of 100 nV. Such small voltages require choppers, AC amplifiers, and synchronous detectors to accurately detect. Power measurements with both kinds of sensors need a power-reference oscillator with a precisely known power output to adjust the calibration of the power meter to fit the particular sensor being used.

The DC output from either the thermocouple or the diode detector is very low-level (on the order of nV or V), so it is difficult to transmit on an ordinary cable because small, undesired thermocouple effects affect the measurement. For this reason Agilent includes the low-level DC circuitry in the power sensor, so only relatively high-level signals appear on the cable. To handle such low DC voltage, you must "chop" the signal to form a square wave, amplify this with an AC-coupled system, then synchronously detect the high-level AC. The chopper and first AC amplifier are included in the power sensor itself.

Once inside the meter, the AC signal is amplified again and passed through a bandpass filter. The narrowest bandwidth is chosen for the weakest signals and the most-sensitive range. As the power meter is switched to higher ranges the bandwidth increases so that measurements can be made more rapidly. A synchronous detector then rectifies the signal which then passes through a low pass filter. A analog-to-digital converter takes the DC signal and equates it to a certain power level.

Power Ranges of the Various Sensor Types

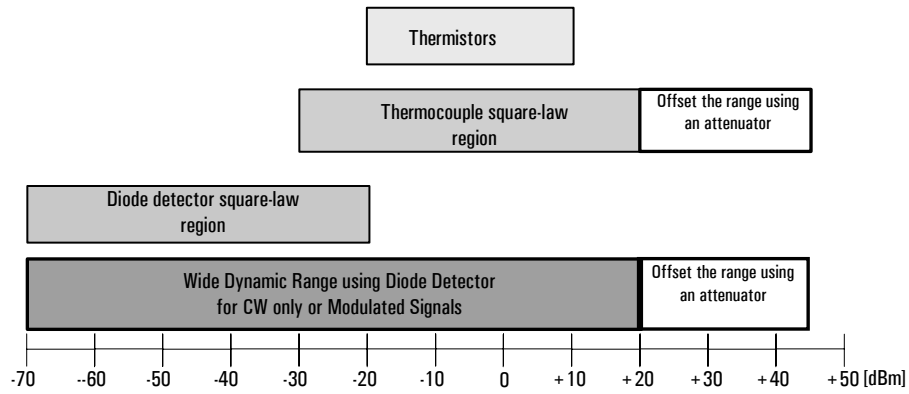

Power Measurement Basics



Agilent Technologies

www.agilent.com/find/backtobasics

Slide 13

Thermistors offer high accuracy, but have a more limited operating range than a thermocouple or diode detector sensor. Thermistor mount specifications are for the range from -20 dBm to +10 dBm.

Thermocouples cover a very large range of powers. Their true square-law region is from -30 dBm to +20 dBm, and with an attenuator can operate up to +44 dBm. Three families of thermocouple sensors cover the complete -30 to +44 dBm range. The A-Series covers -30 to +20 dBm, the H-Series covers from -10 to +35 dBm, and the B-Series covers from 0 to +44 dBm.

Diode detectors (D-Series) have the best sensitivity, allowing them to work well below -20 dBm (stated range is -70 to -20 dBm), but above -20 dBm they begin to deviate substantially from the square-law detection region.

The wide dynamic range power sensors are diode sensors and can provide up to 90dB dynamic range. They either work by correcting for the deviation (CW Power Sensors) or by using the two path technique to allow modulated measurements. Wide dynamic range measurements can be made up to a maximum power of +44dBm.

Thermocouples

- The principles behind the thermocouple

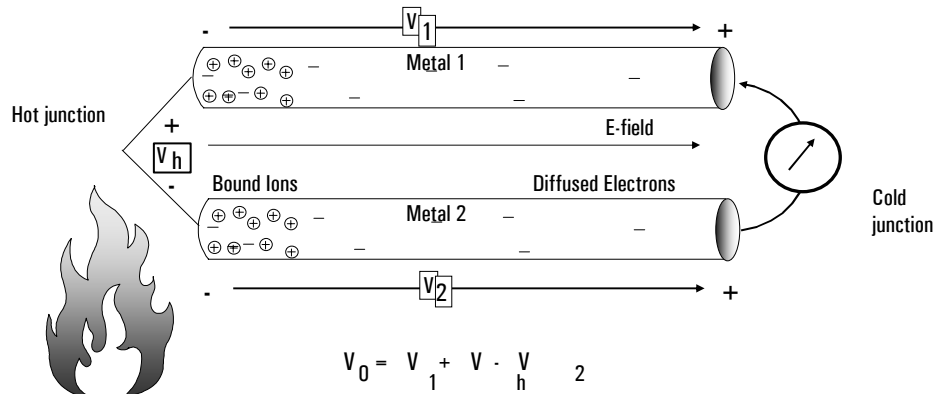

Power Measurement Basics



Agilent Technologies

www.agilent.com/find/backtobasics

Slide 14

Thermocouple technology is the result of combining thin-film and semiconductor technologies to give a very accurate, rugged, and reproducible power sensor. Thermocouple sensors have been the detection technology of choice for sensing RF and microwave power since their introduction in 1974. The two main reasons for this are:

- 1) they operate over a wider power range
- 2) they are more rugged.

Since thermocouples, like thermistors, always respond to the true power of a signal, they are ideal for all types of signal formats from CW to complex digital phase modulations.

The above example shows what happens when a metal rod is heated at one end. As a result of increased thermal agitation, many additional electrons become free from their atoms on the left end. The increased free electron density on the left causes diffusion toward the right. Each electron migrating to the right leaves behind a positive ion. That ion attracts the electron back to the left with a force given by Coulomb's law. Equilibrium occurs when the rightward diffusion force equals the leftward force of Coulomb's law. The leftward force can be represented by an electric field pointing toward the right. The electric field gives rise to a voltage source. Thermocouple sensors are based on the fact that a metal generates a voltage due to temperature differences between a hot and a cold junction and that different metals will create different voltages. A thermocouple is based on the idea of this difference in voltages between the two metals. If the two metals are put together in a closed circuit, current will flow due to the difference in the voltages. If the loop remains closed, current will flow as long as the two junctions remain at different temperatures. In a thermocouple, the loop is broken and a sensitive voltmeter is inserted to measure the net thermoelectric voltage of the loop. The voltage can be related to a temperature change which can be related to the increased temperature due to RF power incident upon the thermocouple element.

Since the voltage produced in a thermocouple is on the order of microvolts, many pairs of junctions or thermocouples are connected in series so that the first junction of each pair is exposed to heat and the second junction is not. In this way the net voltage produced by one thermocouple adds to that of the next, and the next, and so on, yielding a larger thermoelectric output. Such a series connection of thermocouples is called a thermopile. This larger signal makes for simpler sensing circuitry.

Thermocouples

- Thermocouple implementation

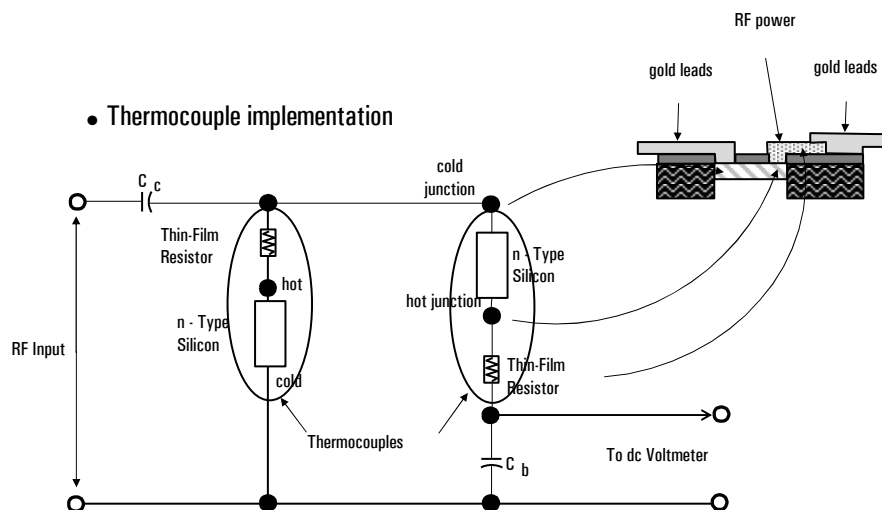

Power Measurement Basics



Agilent Technologies

www.agilent.com/find/backtobasics

Slide 15

One way to implement thermocouple technology to make power sensors is like the method shown above. The sensor contains two identical thermocouples on one chip, electrically connected as in the figure. For DC, the thermocouples are in series, while at RF frequencies they are in parallel. The two thermocouples in parallel form a 50 ohm termination for the RF transmission line.

Thermocouple measurements are open-loop, meaning an external reference source is necessary to match a particular sensor with its associated meter. The power reference is contained in the power meter. To verify the accuracy of the system, or adjust for a sensor of different sensitivity, the user connects the thermocouple sensor to the power-reference output and, using a calibration adjustment, sets the meter to display 1.00 mW. This calibration effectively transforms the system to a closed-loop substitution-type system, and provides confidence in traceability back to internal company standards or NIST standards.

Diode Detectors

- How does a diode detector work?

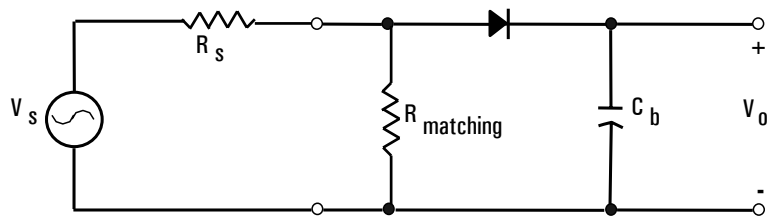

Power Measurement Basics



Agilent Technologies

www.agilent.com/find/backtobasics

Slide 16

Unlike thermistors and thermocouples, a diode does not measure the heat content of a signal but rectifies the signal instead. The matching resistor (approximately 50 ohms) is the termination for the RF signal. RF voltage is turned to a DC voltage at the diode, and the bypass capacitor is used as a low-pass filter to remove any RF signal getting through the diode.

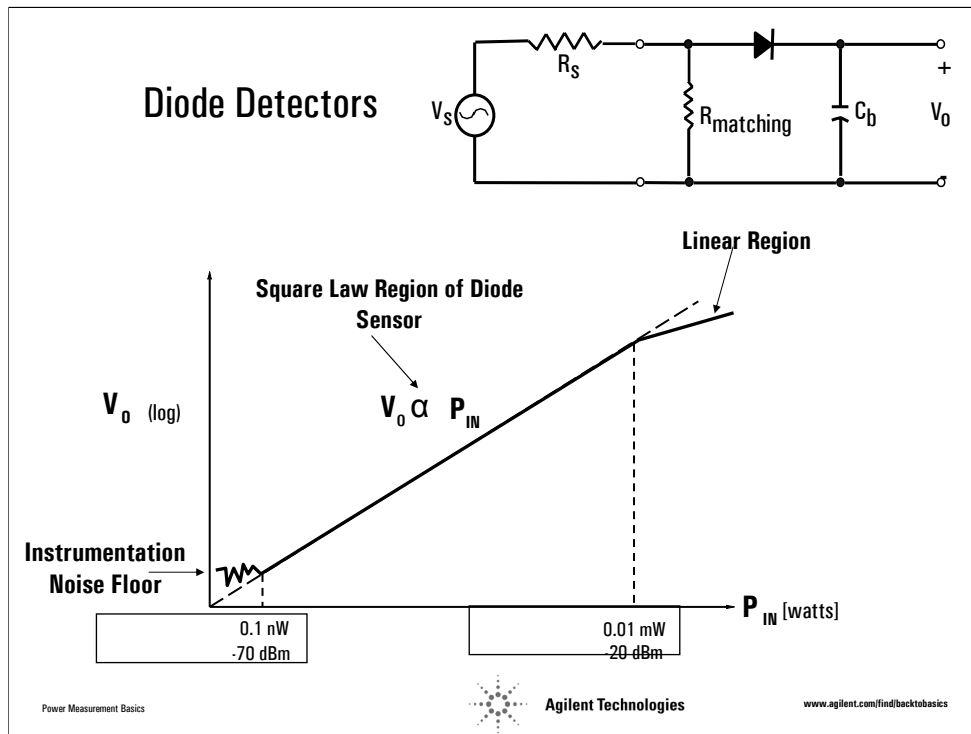

Slide 17

Unlike thermistors and thermocouples, a diode does not measure the heat content of a signal but rectifies the signal instead. The matching resistor (approximately 50 ohms) is the termination for the RF signal. RF voltage is turned to a DC voltage at the diode, and the bypass capacitor is used as a low-pass filter to remove any RF signal getting through the diode.

A major attribute of the diode sensor is sensitivity, permitting power measurements as low as -70 dBm (100 pW). Are these true power measurements, independent of signal content? That depends. If we expand the diode equation (see Agilent Technologies Application Note 64-1A) into a power series, we find that the rectified output voltage is a function of the square of the input signal voltage up to a power level of about -20 dBm. This performance yields a rectified output that is proportional to the RF signal power regardless of signal content. As the power level increases above -20 dBm, the rectification process becomes more and more linear and the output voltage becomes a function of the input voltage. For complex signals, the output is then dependent upon the phase relationships among the various components of the input signal.

Many types of diodes have been used for power measurement and today the most commonly used type is the low-barrier Schottky diode. In this presentation we will discuss the diode-type that is used in Agilent's diode sensors, that is, PDB (planar-doped-barrier) diodes. PDB diodes have better performance than Schottky diodes at microwave frequencies. Sensors based on this technology are able to detect and measure power as low as -70 dBm at frequencies up to 18 GHz. PDB diode technology provides some 3000 times (35 dB) more-efficient RF-to-DC conversion compared to the thermocouple previously discussed. Diode sensor technology excels in sensitivity, although realistically, thermocouple sensors maintain their one primary advantage as pure square-law detectors for the range -30 to +20 dBm.

In detecting power levels of -70 dBm the diode detector output is about 50 nV. The low signal level requires sophisticated amplifier and chopper circuit design to prevent leakage signals, noise, and thermocouple effects from dominating the signal of interest.

Wide-Dynamic-Range CW-only Power Sensors

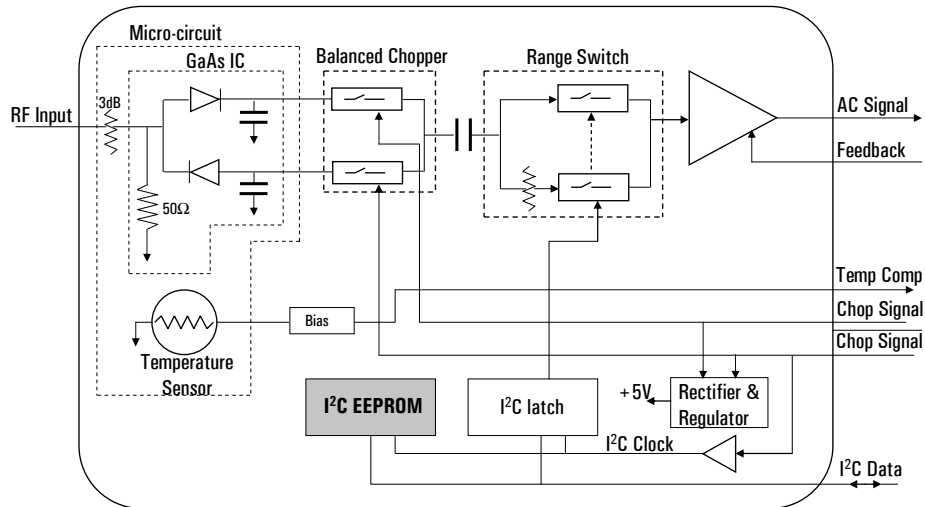

Power Measurement Basics



Agilent Technologies

S1

www.agilent.com/find/backtobasics

Slide 18

Agilent Technologies wide-dynamic-range CW-only power sensors make measurements outside the square-law region of the diode. To achieve the expanded dynamic range of 90-dB, the sensor/meter architecture depends on a data compensation algorithm which is calibrated and stored in an individual EEPROM in each sensor. The data algorithm stores information of three parameters, input power level vs frequency vs temperature for the ranges specified for the sensor.

At the time of sensor power-up, the power meter interrogates the attached sensor and uploads sensor calibration data. An internal temperature sensor supplies the diode's temperature data for the temperature-compensation algorithm in the power meter.

E-series E9300 Average Power Sensors Technology

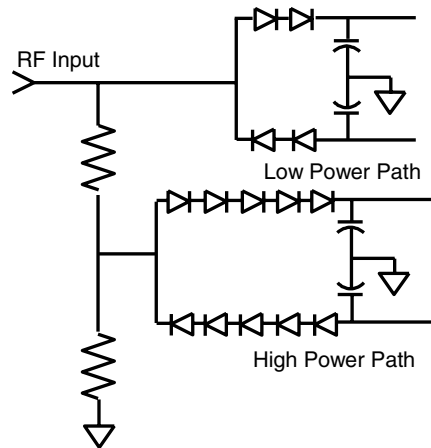

Innovative Design:

- Diode stack- attenuator- diode stack topology
- Two paths with an automatic switch point

Power Measurement Basics



Agilent Technologies

www.agilent.com/find/backtobasics

Slide 19

The corrections for the CW signals are fine but what can be done for other signals which may be modulated? The E9300 Power Sensors are diode power sensors which give 80dB Dynamic Range. To get this range a two path design is used with a separate path for the low power and high power paths. This innovative design is based on a diode stack /attenuator/diode stack topology.

Each diode stack forms a measurement path, the high power path is between -10 to +20dBm and the low power path is between -60 to -10dBm. Only one path is active at any time and switching between paths is fast, automatic and transparent to the user. This topology has the advantage of always maintaining the sensing diodes within their square law region and will therefore respond properly to complex modulation formats as long as the correct range is selected.

The design is further refined by incorporating diode stacks in place of single diodes to extend square law operation to higher power levels at the expense of sensitivity. In the E9300 the low power path uses a two diode stack pair and the high power path a five diode stack pair. FET switches were used off chip to enable the low path diodes to self bias to an off condition when not in use.

Advantages of the E-series E9300 sensor architecture

- Sensor diodes always kept in square law region:
 - means accurate measurement of signals with arbitrarily wide modulation bandwidth, and accurate measurement of signals with high peak to average ratios

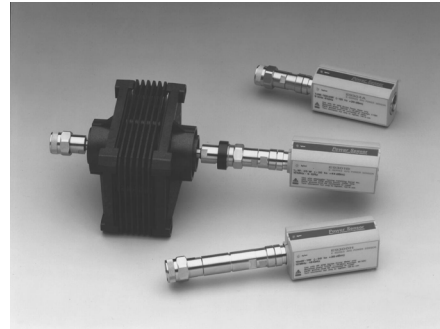
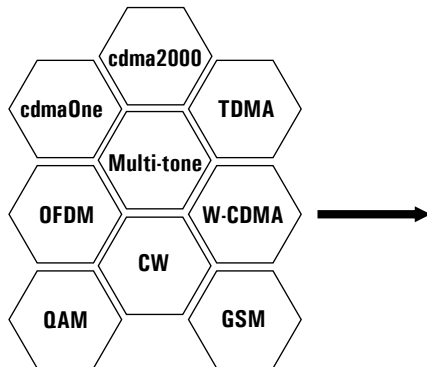

Power Measurement Basics



Agilent Technologies

www.agilent.com/find/backtobasics

Slide 20

As mentioned the diode stack/attenuator/diode stack technique has the advantage of always using the diodes within their square law region.

In this region, the output current (and voltage) of each diode is proportional to the input power. As a result, the E-Series E9300 power sensors respond accurately to measure average power on signals ranging from the most complex digital format to CW. This means that one E-series E9300 power sensor can be used to measure the average power of any signal.

The E9300 Power Sensor can handle power levels up to +33dBm peak with duration less than 10microseconds mean that these power sensors can be used for signals with high crest factors (or peak to average ratios). If the high peaks could not be handled this would effectively limit the dynamic range of the power sensor.

The fact that it is a pure diode sensor also means that there is no modulation bandwidth limitations that you get with power sensors which use a sampling technique.

Advantages of the E-series E9300 sensor architecture

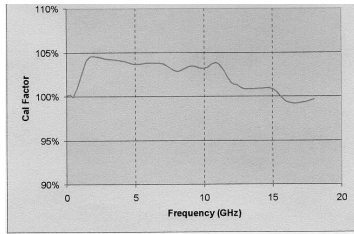

High Path Cal Factor

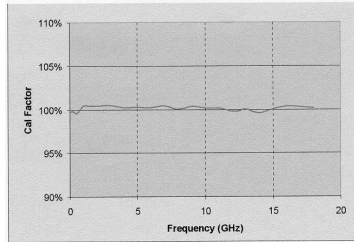

Low Path Cal Factor

- Flat calibration factors give accurate measurement of multi-tone signals.



Slide 21

The E9300 Power Sensors have flat calibration factors which is an advantage if multi tone signals are being measured. If there are multi tone signals being input, only one calibration factor can be selected. If the calibration factors are flat over the frequency range of the measurements then the uncertainty in the result will be kept to a minimum.

Agenda

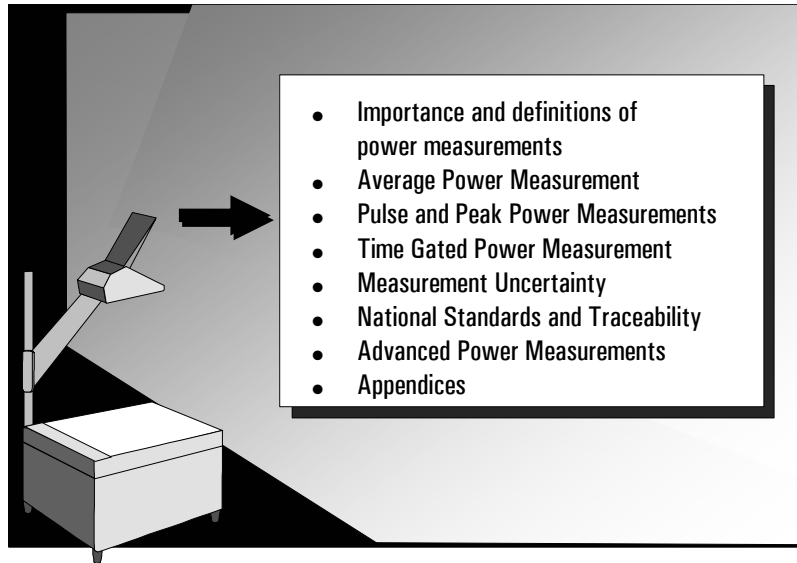

Power Measurement Basics



Agilent Technologies

www.agilent.com/find/backtobasics

Slide 22

In many cases you may require more than just the average power of your signal. For example, if you are operating an amplifier close to its maximum input level, you may be interested in the peak value of the output signal in order to determine if the amplifier is working in its linear region or in compression. Another example where peak power is important is in measuring W-CDMA signals as they commonly exhibit a high crest factor (the ratio of the signal's peak value to its root-mean-square (rms) value). The peak power or peak-to-average ratio measurement is important in characterizing W-CDMA power amplifiers.

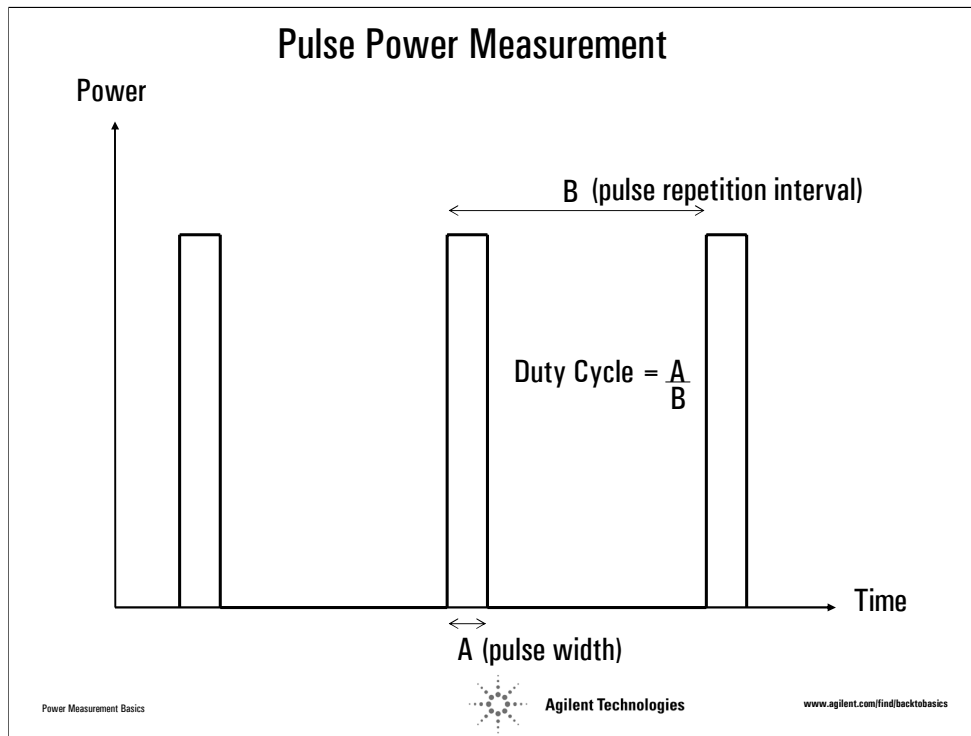

Slide 23

Pulse power was traditionally determined by measuring the average power of the pulse and then dividing the measurement result by the pulse duty cycle value to obtain the pulse power reading. The measurement result is a mathematical representation of the pulse power rather than an actual measurement and assumes constant peak power. The pulse power averages out any aberrations in the pulse, such as overshoot or ringing. For this reason it is called pulse power and not peak power or peak pulse power.

In order to ensure accurate pulse power readings, the input signal must be a rectangular pulse. Other pulse shapes (such as triangle or Gaussian) will cause erroneous results. This technique is not applicable for digital modulation systems, where the duty cycle is not constant, and the pulse amplitude and shape is variable.

Envelope Power and Peak Envelope Power

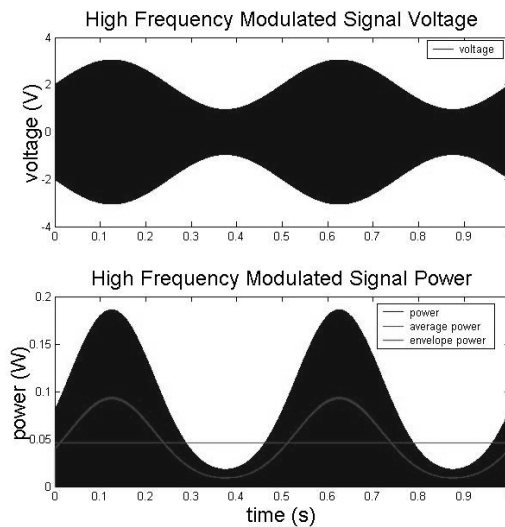

Power Measurement Basics



Agilent Technologies

www.agilent.com/find/backtobasics

Slide 24

This slide shows the power envelope of a high frequency modulated signal. Peak mode measurements are defined as measurements of the envelope power of an RF signal over several periods of the RF carrier wave.. Envelope power measurements thus allow engineers to examine the effects of modulation or transient conditions without examining details of the RF carrier waveform.

Peak envelope power is a term for describing the maximum power. The peak of the red line (the envelope power) is what is measured as peak power by an RF peak power meter. If the absolute peak power is required, then 3dB must be added to the peak power measured by the peak power meter.

It should be noted that the average power, pulse power and peak envelope power all provide the same answer for a CW (continuous wave) signal, which has a flat envelope power.

Peak Power Measurement System Characteristics

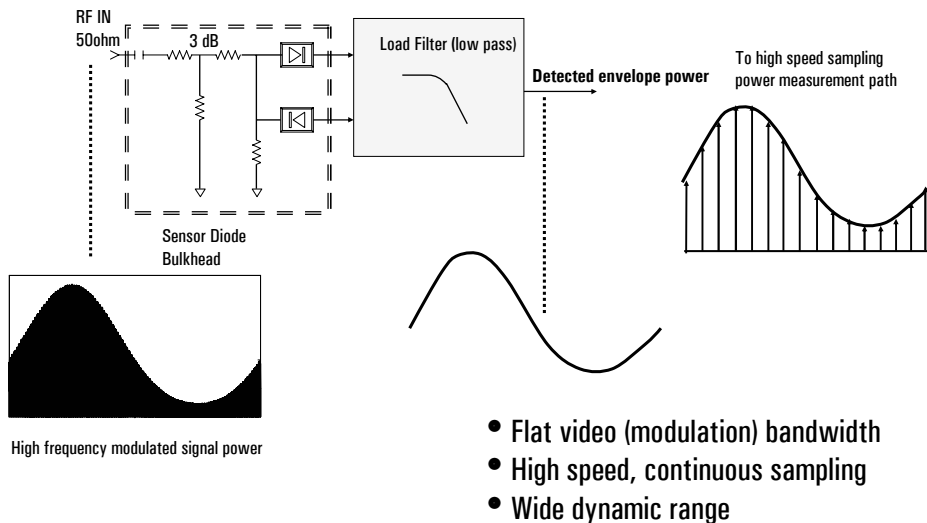

Power Measurement Basics



Agilent Technologies

www.agilent.com/find/backtobasics

Slide 25

For complex digital modulation signals, such as wideband-CDMA (W-CDMA), an instantaneous power measurement is required in order to obtain an accurate measurement of the peak power or peak-to-average ratio, sometimes referred to as the crest factor.

Peak power meters are designed to provide accurately calibrated detection of envelope power across a wide dynamic range. A key part of the peak power measurement system is the power sensor. For a signal with a fast changing power envelope, the detected envelope power must change at the same rate as the input signal power in order to make accurate peak power measurements. To have the capability to make peak measurements, sufficient video bandwidth is required to allow this change to be followed, thus the load filter (RCL) network, plus the video resistance of the diode sensing element go a long way in dictating the video bandwidth. Note that the video bandwidth is sometimes referred to as the modulation bandwidth, this should not be confused with the RF bandwidth which dictates what range of frequencies the sensor can measure. There is also an engineering compromise to be made between video bandwidth and dynamic range, the compromise being the wider the video bandwidth, the smaller the dynamic range. So when choosing a sensor to measure a particular format, to achieve maximum dynamic range and the minimum uncertainty on a measurement, a sensor with the video bandwidth just larger than the modulation bandwidth of the format should be selected.

In the case of the Agilent EPM-P power meters and E9320 sensors, the detected envelope power is input to a high speed, continuous sampling power measurement path. The detected power envelope is sampled at 20 Msamples per second thus ensuring accurate pulse profiling of complex modulation formats, with up to 5 MHz video bandwidth.

Continuous Sampling versus Random Sampling

What are the advantages of the 20Msamples/s continuous sampling compared to random sampling for power measurements?

- Continuous sampling ensures that the peak power is captured on single shot signals
- Random sampling takes longer to build up the trace display



Slide 26

Why did we choose continuous sampling compared to random sampling. As previously mentioned, the EPM-P power meters have a 20Msamples/s continuous sampling rate to allow accurate profiling of the signal being measured. In the design of a sampling power meter the choice can be made between continuous sampling and random sampling and for pulse measurements there are some clear advantages of continuous sampling.

Continuous sampling allows the signal to be captured if a single shot measurement is made. This is an advantage if the pulse you are trying to capture is not repetitive. If random sampling is used then there is no guarantee that the peak signal will be captured. For repetitive signals the trace can be built up but this happens over a number of traces and therefore it takes longer to build the display.

If continuous sampling is employed we know exactly what points are being measured and therefore we can correct the readings for the bandwidth to ensure the accuracy of the measurement is optimized. If random sampling is employed the typical approach is to use a higher frequency calibrator, typically 1 GHz, which is used as the source of the calibration.

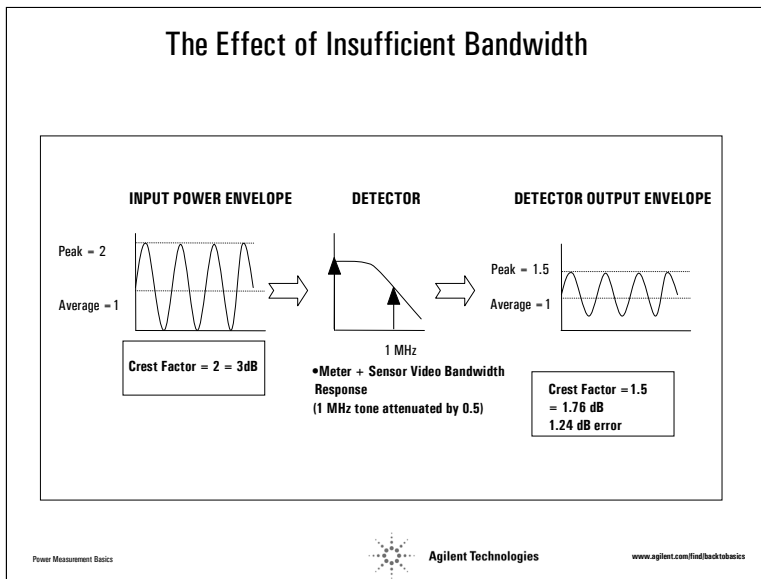

Slide 27

Let's look at the effect on the peak measurement when not having sufficient bandwidth for the signal-under-test.

For the case of a signal comprising two RF tones separated by 1 MHz and of equal amplitude, the power envelope is a 1 MHz sine-wave superimposed on the average power. The average power is equal to the sum of the power in each tone, and the peak power is twice this average, so the sine wave varies between zero and twice the average. The signal has a 3 dB peak-to-average ratio. When a diode power sensor measures this signal, a DC component corresponding to the average power and a component at 1 MHz corresponding to the sine-wave variation in power envelope is generated. Any video bandwidth roll-off will directly effect the peak measurement but leave the average power unaffected. If the video bandwidth of the power meter/sensor is quoted as having a 3 dB bandwidth a 1 MHz, the sine-wave tone is attenuated by half. So, although this might be sufficient bandwidth to measure the average power, a 1.24 dB error will be present in the peak-to-average ratio measurement, therefore making a significant error.

The moral being to ensure that when you are making peak power measurements, that the sensor and meter's video, or modulation, bandwidth is flat for the signal level under test. If the video bandwidth is not flat then the integrity of the peak power measurement is compromised.

Agenda

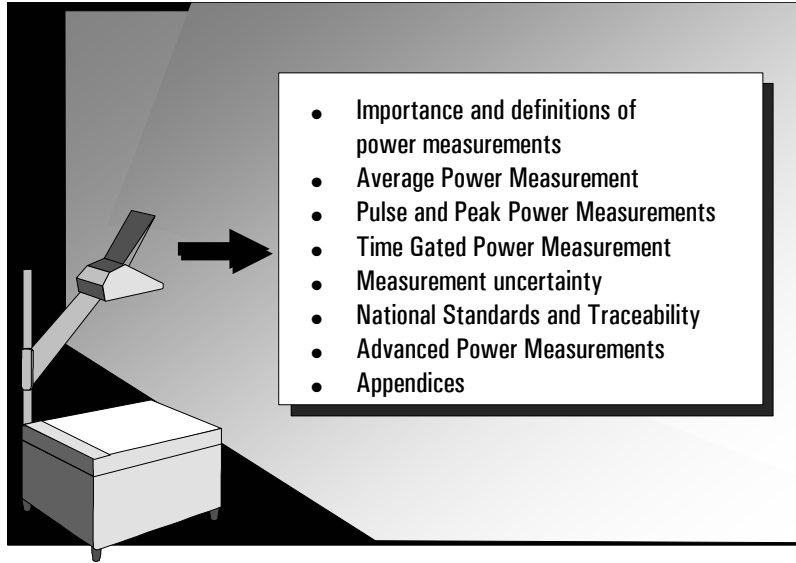

- Importance and definitions of power measurements
- Average Power Measurement
- Pulse and Peak Power Measurements
- Time Gated Power Measurement
- Measurement uncertainty
- National Standards and Traceability
- Advanced Power Measurements
- Appendices



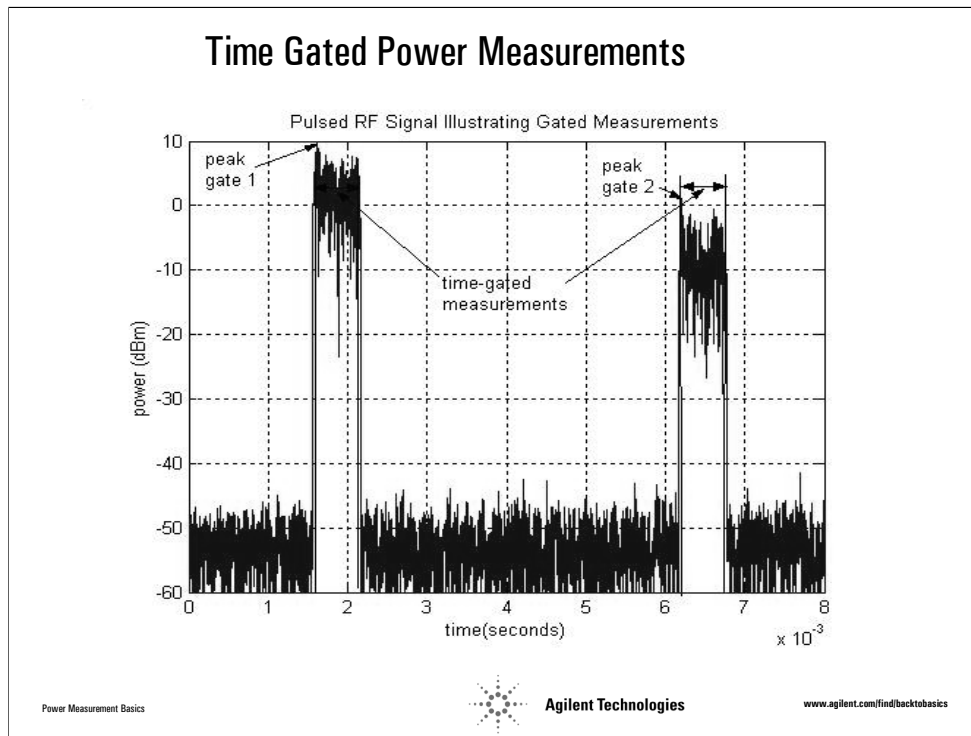

Slide 29

Time-gated average power, peak power and peak-to-average ratio on TDMA and CDMA signals are the core measurement requirements of a power measurement system for today's wireless standards. As these standards evolve, the capability to make peak, peak-to-average ratio and average measurements on a single burst is required. This allows fuller characterization of signals like EDGE (Enhanced Data rates for GSM Evolution), which has an amplitude varying modulation format within the RF burst as shown on this slide.

To make time-gated power measurements on TDMA type pulses, the measurement system must have sufficient rise and fall times to ensure that the gated section being measured is actually the signal and not a latent effect of a slow rising or falling edge caused by insufficient measurement response times. If overshoot is to be characterized, the power sensor rise and fall time specifications must be fast enough to follow the rising and falling edges of the signal under test. It is generally recommended that the power sensor should have a rise time of no more than one-eighth of the expected signals rise time, in order to obtain accurate results. This will minimize the error introduced by the sensor and meter responses. The E9320 peak and average sensors have a 200 ns rise time and fall time specification (E9323A and E9327A 5 MHz video bandwidth sensors), making them ideal for wireless formats. However, if only the time-gated (burst) average power is being measured, then a rise time similar to that of the signal can be used. Although the rising edge of the burst will introduce a delay in how quickly the measured pulse rises, the start of the time-gated measurement can be delayed to account for this. In this manner, accurate time-gated average power measurements can be made.

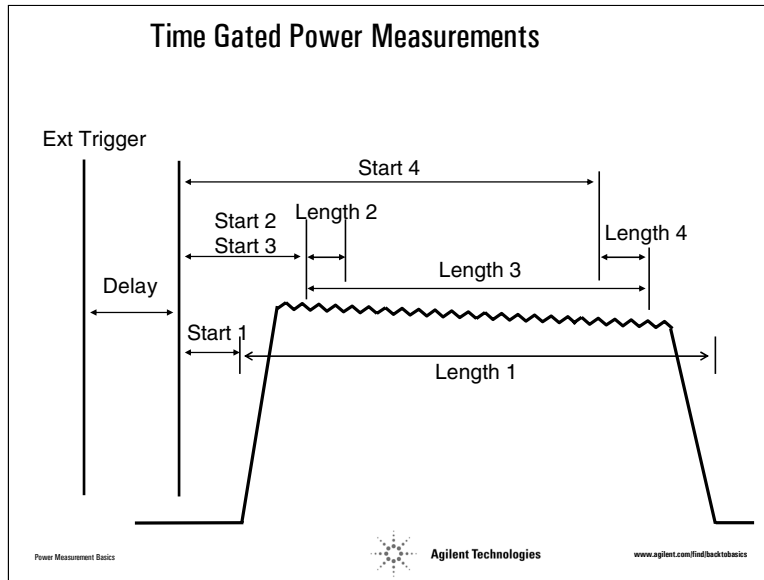

Slide 30

This slide shows the time-gated and triggering capabilities of the EPM-P power meters and how they tie in to the measurements required by the wireless communications and radar markets.

The time gated measurements are performed using the EPM-P power meters extensive triggering capabilities(level, external and GPIB triggering), and includes the ability to have 4 separate measurements on a single burst. This is shown in the slide where 4 independent start delays and gate lengths can be set from the trigger event. Each of these 4 measurements, during the Length timeframe, can be set up to measure peak, average or peak-to- average ratio. For example, this allows users to make a peak measurement on the overshoot and measure the average power over the 5% to 95% part of the burst, and for the EDGE wireless format, this feature allows power measurements on the different amplitudes which can be set up in different timeslots.

Agenda

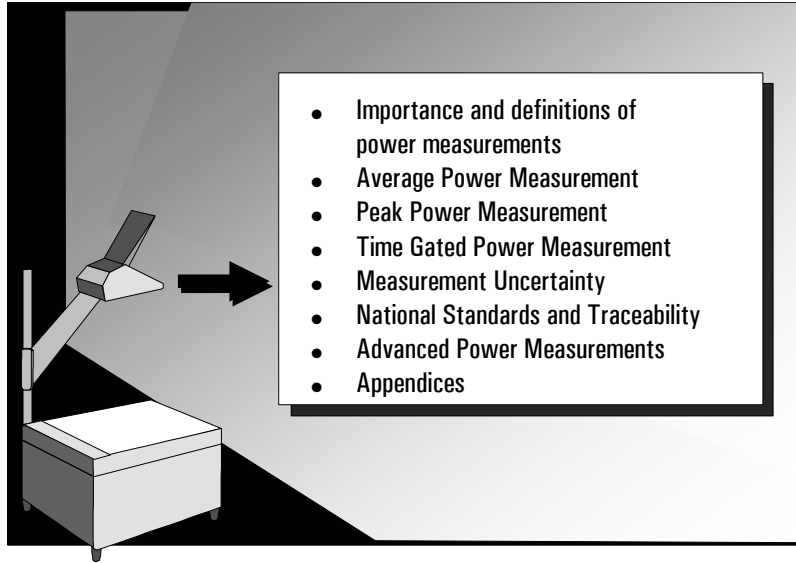

- Importance and definitions of power measurements
- Average Power Measurement
- Peak Power Measurement
- Time Gated Power Measurement
- Measurement Uncertainty
- National Standards and Traceability
- Advanced Power Measurements
- Appendices



Sources of Power Measurement Uncertainty

- Sensor and Source Mismatch Errors
- Power Sensor Errors
- Power Meter Errors

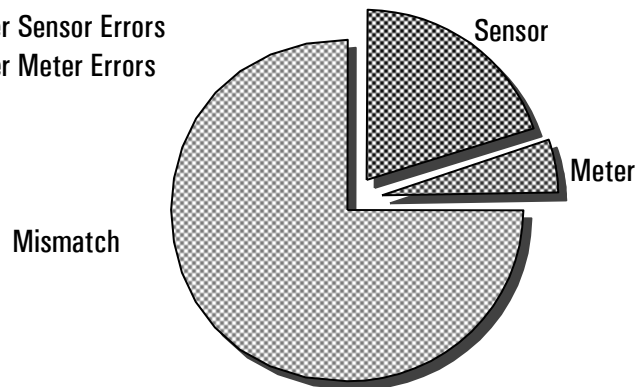

Power Measurement Basics



Agilent Technologies

www.agilent.com/find/backtobasics

Slide 32

The word 'uncertainty' means doubt, and thus in its broadest sense 'uncertainty of measurement' means doubt about the validity of the result of a measurement.

In power measurements, like all measurements, there are many sources of uncertainty (error). Sensor and source impedance mismatch typically cause the largest errors in power measurements. By knowing the VSWRs (voltage standing wave ratios) of the sensor and source, uncertainty due to mismatch can be found. Other sensor uncertainties such as calibration factor and linearity are also considered. An analysis of the various instrumentation uncertainties of the power meter follows. Finally, an example combining all errors for a total uncertainty number will be shown.

Calculation of Mismatch Uncertainty

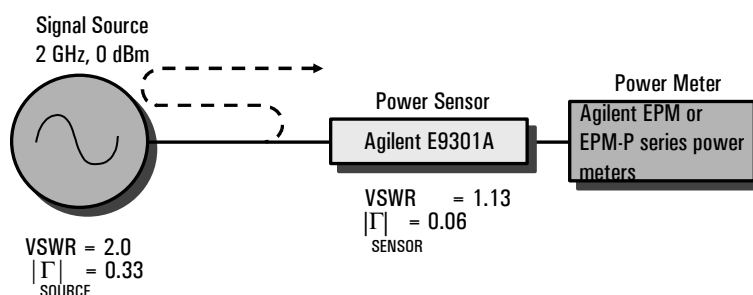

$$\text{Mismatch Uncertainty} = \pm 2 \times |\Gamma|_{\text{SOURCE}} \times |\Gamma|_{\text{SENSOR}} \times 100\%$$

$$\text{Mismatch Uncertainty} = \pm 2 \times 0.33 \times 0.06 \times 100\% = \pm 3.96\%$$

$$|\Gamma| = \frac{\text{VSWR} - 1}{\text{VSWR} + 1}$$

Power Measurement Basics



Agilent Technologies

www.agilent.com/find/backtobasics

Slide 33

In a power measurement, we are usually interested in the power delivered to an impedance of Z_0 , so naturally we want the power sensor to be as close to Z_0 as possible. When the sensor is exactly Z_0 , none of the signal reflects from the sensor but rather is completely absorbed. Anytime that the sensor impedance deviates from this impedance, reflections will occur. This means that a portion of the source power never reaches the sensing element (and therefore cannot be measured). Similarly, the source will typically be mismatched also and reflections will occur there too. The exact power level actually entering the sensor is unknown since the complex reflection coefficient is not typically known, but rather only the VSWR. Although the exact power cannot be found, the maximum and minimum values of the power can be calculated.

Mismatch uncertainty is the uncertainty due to the imperfect matches of the source and sensor. The degree of mismatch uncertainty is found using known VSWR values for both the sensor and the source. The Agilent E9301A Power Sensor has a VSWR of 1.13 at 2 GHz and the source has an assumed VSWR of 2.0. A mismatch uncertainty percentage is found by using the equation in the figure. In this example, the mismatch contributes +/-3.96% uncertainty to the measurement.

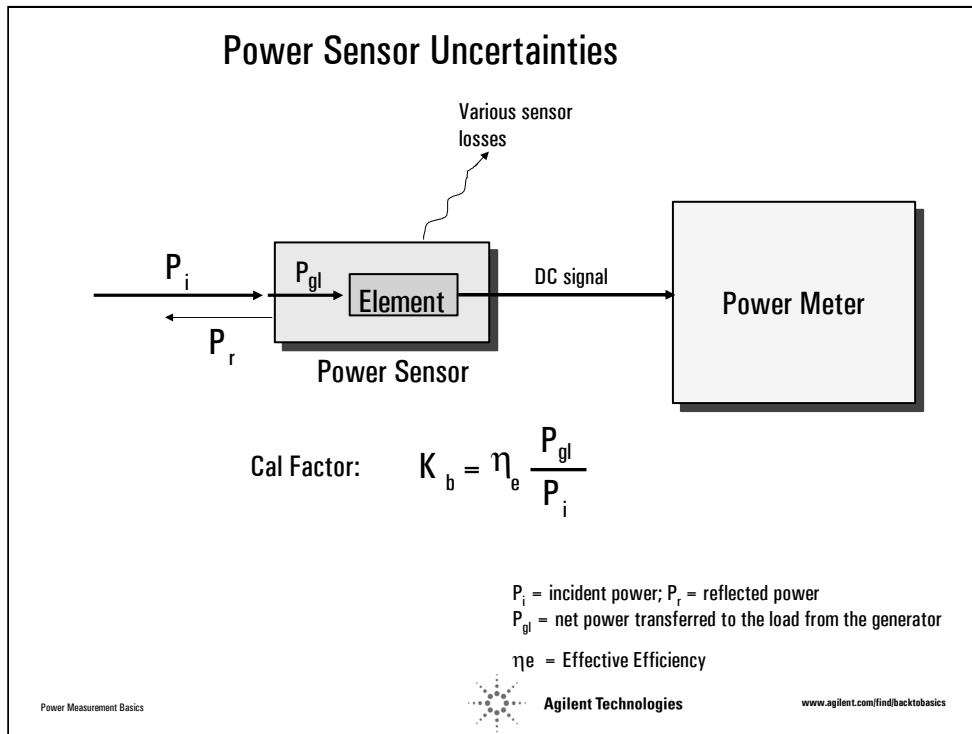

Slide 34

For a power sensor the "power in" (P_{gl}) is the net power delivered to the sensor. It is the incident power (P_i) minus the reflected power (P_r), however not all that net input power is dissipated in the sensing element, for example, some of the power is turned into heat in the instrumentation of the sensor. The metered power indicates only the power that the sensing element itself dissipates.

Calibration factor (K_b) takes into account the imperfect efficiency of the sensor and the mismatch loss, which accounts for the reflected signal. In the slide you see that calibration factor,

$$K_b = \eta_e \frac{P_{gl}}{P_i}$$

where η_e is the effective efficiency and $\frac{P_{gl}}{P_i}$ is the mismatch loss. The calibration factor is unique to each sensor and is determined by the manufacturer on the production line. The calibration factor is either printed on the power sensor label (as with the Agilent 8480 series sensors) or stored in EEPROM (as with the Agilent E-series sensors). A data sheet containing the sensor's unique calibration factor and reflection coefficient data is shipped with each sensor. The calibration factor uncertainty, though, is common to a sensor model and is specified by the manufacturer. For the E4412A at 10 GHz the calibration factor uncertainty is 3.1% at 0 dBm.

Since the calibration factor correction data will seldom be used manually, it is no longer listed on the sensor label of the Agilent E-series sensors. The data is always uploaded into the power meter on power-up or when a new sensor is connected. The new sensors store cal factor tables for two different input power levels to improve accuracy of the correction routines. If the cal factor changes upon repair or recalibration, the new values are loaded into the sensor EEPROM.

Power Meter Instrumentation Uncertainties

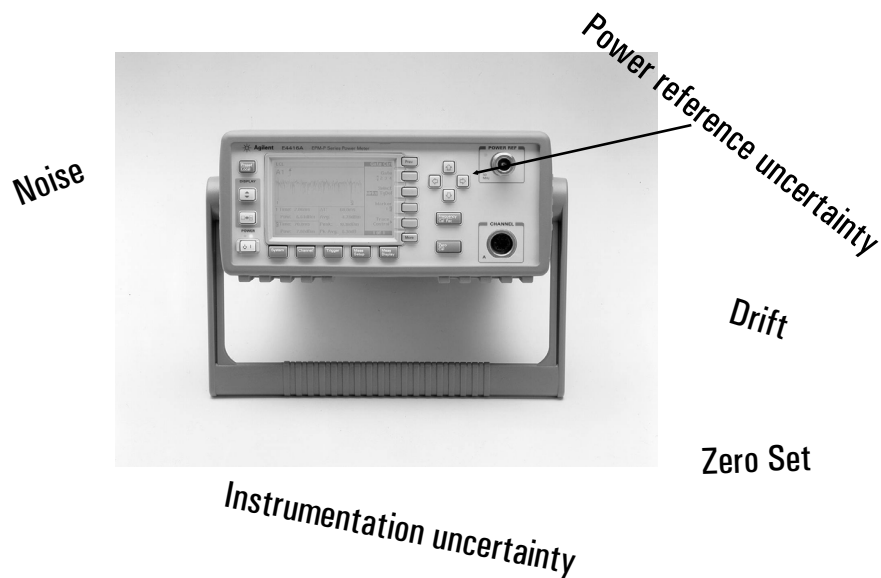

Power Measurement Basics



Agilent Technologies

www.agilent.com/find/backtobasics

Slide 35

There are a number of uncertainties associated with the electronics inside the power meter. These uncertainties should be included for a complete uncertainty analysis, even though they typically are smaller than the source sensor mismatch and sensor uncertainties.

Power reference uncertainty

Thermocouple or diode sensors require a highly accurate, known power source to verify and adjust for the sensitivity of the individual sensor. The Agilent EPM and EPM-P series power meters have, as standard, a 1.0 mW, 50 MHz calibration source. The power reference uncertainty deals with the uncertainty in the output of this calibration source. A specification of 1.07% accuracy uncertainty, for one year, at 25 +/- 10 degrees C, is provided for the EPM-P series power meters.

Instrumentation uncertainty

Instrumentation uncertainty is the combination of such factors as meter tracking, circuit non-linearities and amplifier gain uncertainties. The instrument manufacturer guarantees the accumulated uncertainty is within a certain limit, for example, the instrumentation uncertainty for the EPM and EPM-P series power meters is +/- 0.5% for absolute average power measurements.

Judgement: What is an acceptable measurement uncertainty?



- Reasonable Error Limits:
 - 0.5 dB?
 - or 12%

Which is the larger error?

Power Measurement Basics



Agilent Technologies

www.agilent.com/find/backtobasics

Slide 36

Uncertainties expressed in dB tend to validate the “Marketing Manager’s Law of Small Numbers” That is, a small numbered specification sounds better!

For example, in an informal poll of six test engineers stating that 1.0 dB error was acceptable, dismissed a 20% error as unacceptable, however 20% error is actually less than 1.0 dB, which as a percentage is +26%, -21%.

Now let’s look at the worst sources of uncertainty when making power measurements and common methods of combining the uncertainties.

Calculating Power Measurement Uncertainty

Mismatch uncertainty: $\pm 3.96\%$

Power Linearity: $\pm 2.0\%$ ¹

Cal Factor uncertainty: $\pm 1.8\%$ ¹

Power reference uncertainty: $\pm 1.07\%$ ¹

Instrumentation uncertainty: $\pm 0.5\%$

¹ Specifications apply for an E9301A sensor and EPM or EPM-P series power meter, over 25 ± 10 degrees C temperature range

Now that the uncertainties have been determined, how are they combined?

Power Measurement Basics



Agilent Technologies

www.agilent.com/find/backtobasics

Slide 37

Here are the largest sources of individual uncertainties for our example power measurement. Now we want to determine how these uncertainties act together to affect the final measurement result. Power measurement uncertainties are typically denoted in one of two ways: worst-case and root-sum-of-the-squares (rss). Let's examine these two methods.

Note that for this example the uncertainties listed above apply for the E9301A power sensor and EPM-P series power meter measuring a 2 GHz signal at 0 dBm. Some specifications apply to a reduced temperature range of 25 ± 10 degrees C. The calibration factor uncertainty is specified at different frequency points within the range of the sensor and can be found in the technical specifications of the sensor. The mismatch uncertainty will depend on both the SWR of the source and the sensor. The maximum VSWR of the sensor for a certain frequency range can be found in the technical specifications, and the VSWR of the source, from specifications related to the source.

At this power level (0 dBm) zeroing errors and noise are not included. At lower power levels these errors can be very significant and should be included in any uncertainty analysis.

Worst-Case Uncertainty

- In our example worst case uncertainty would be:

$$= 3.96\% + 2.0\% + 1.8\% + 1.07\% + 0.5\% = \pm 9.33\%$$

$$+9.33\% = 10 \log (1 + 0.093) = +0.39 \text{ dB}$$

$$-9.33\% = 10 \log (1 - 0.093) = -0.42 \text{ dB}$$



Slide 38

One value of total uncertainty frequently assigned to a power measurement is the worst-case uncertainty. This situation comes about if all the possible sources of error were at their extreme values and in such a direction as to add together constructively and therefore achieve the maximum possible deviation between the measured and actual power value.

This worst-case approach results in an uncertainty of $\pm 9.33\%$, or $+0.39, -0.42$ dB.

Note: It is VERY unlikely that all errors will add together, making this worst-case scenario extremely conservative. A more realistic method of combining uncertainties is the root-sum-of-the-squares (RSS) method as shown on the next slide.

* Combining the Measurement Uncertainties

Source of Uncertainty	Value ±%	Probability Distribution	Divisor	Standard Uncertainty u_i (k=1)
Source/Sensor Mismatch at 2 GHz	3.96	U-shaped	1.414	2.8
Calibration Factor Uncertainty at 2 GHz	2.0	Normal	2	1.0
Linearity at 0 dBm	1.8	Normal	2	0.9
Power Reference Uncertainty	1.07	Normal	2	0.53
Instrumentation Uncertainty	0.5	Normal	2	0.25

Combined Standard Uncertainty $u_c = \text{RSS of } u_i$

Expanded Uncertainty (k=2) = 2 x u_c

* In accordance to guidelines published in the "ISO Guide to the Expression of Uncertainty in Measurement" and the "ANSI/NCSL Z540-2-1996 US Guide to the Expression of Uncertainty in Measurement"

Power Measurement Basics



Agilent Technologies

www.agilent.com/find/backtobasics

Slide 39

This table summarizes the the sources of uncertainty. Each source of uncertainty is normalized to a one sigma value (Coverage Factor k = 1) as determined by the probability distribution. The Coverage Factor is like a guard band, and the value is chosen on the basis of the level of confidence required for the specification, typically in the range 1 to 3 . A coverage factor of 2 provides a confidence level of 95.45 %, and a coverage of 3 provides 99.73% confidence.

For most data sheet specifications, the divisor used to convert to one sigma is either 2, for normal distribution, or the square root of 3, for rectangular distribution. Rectangular distribution is used when it is only possible to estimate upper and lower specification boundaries, and the probability is that the uncertainty is equal to the value stated. Normal distribution is shaped like a bell, where the mean, median and mode have the same value, this value corresponding to the highest point on the curve.

The source sensor mismatch is the odd one out and has U-shaped distribution, with a divisor equal to the square root of 2. U-shaped distribution has the property where there is a greater chance that the uncertainty value is near the limits than it is near the middle of the U-shape.

Once all the individual sources of uncertainty have been normalized for one sigma, the combined standard uncertainty is calculated using the root-sum-of-the-squares. The expanded uncertainty is then calculated usually to a coverage factor of 2 as shown on the next slide.

Combined Standard Uncertainty (u_c), using the Root Sum of the Squares (RSS)

• In our example, the u_c would be:

$$= \sqrt{(2.8)^2 + (1.0)^2 + (0.9)^2 + (0.53)^2 + (0.25)^2}$$

$$= \pm 3.16\%$$

• The Expanded Uncertainty (u) = $2 \times 3.16 = \pm 6.32\%$

$$+ 6.3\% = 10 \log(1 + 0.063) = +0.27 \text{ dB } (+0.39 \text{ dB worst case})$$

$$- 6.3\% = 10 \log(1 - 0.063) = -0.28 \text{ dB } (-0.42 \text{ dB worst case})$$



Slide 40

As mentioned earlier, a more realistic method of combining uncertainties is the root-sum-of-the-squares (rss) method. The rss uncertainty is based on the fact that most of the power measurement errors, although systematic and not random, are independent of each other. Since they are independent of each other, they are random with respect to each other and combine like random variables.

In our example, the rss method of combining the errors obtains an Expanded Uncertainty of $\pm 6.32\%$, or $+ 0.27, - 0.28$ dB. This contrasts favourably with the pessimistic worst case analysis shown in red. This technique is used in many engineering situations, from working out test line limits to Metrology Lab calibrations.

A reference for calculating power meter measurement uncertainties is obtained in Agilent Technologies Application Note 64-1C, Fundamentals of RF and Microwave Power Measurements. Also a practical measurement uncertainty calculator can be found on our Power internet page:

<http://www.agilent.com/find/powermeters>

Agenda

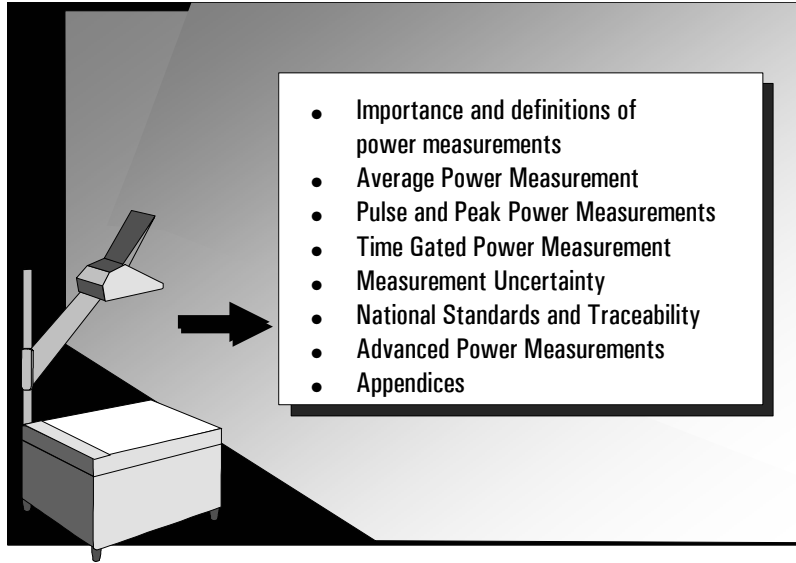

- Importance and definitions of power measurements
- Average Power Measurement
- Pulse and Peak Power Measurements
- Time Gated Power Measurement
- Measurement Uncertainty
- National Standards and Traceability
- Advanced Power Measurements
- Appendices



National Standards and Traceability

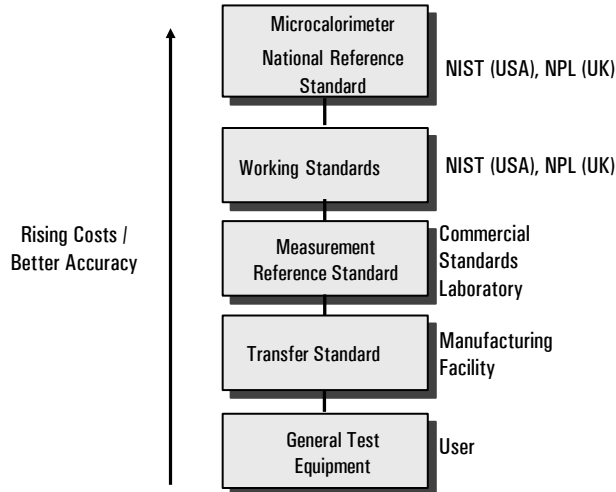

Power Measurement Basics



Agilent Technologies

www.agilent.com/find/backtobasics

Slide 42

It is important that power measurements can be duplicated at different times and at different places. This requires well-behaved equipment, good measurement technique, and a common agreement as to what is the standard watt. The U.S. National Institute for Standards and Technology (NIST) in Boulder, Colorado maintains the National Reference Standard in the form of a microwave microcalorimeter. A similar function is provided by the National Physical Laboratories (NPL) in the UK and other national standard organizations throughout the world.

A power sensor referenced back to national standards in the USA, is said to be traceable to NIST. The usual path of traceability for a power sensor is shown on the slide. Since any errors introduced in the watt at NIST will flow down to all other standards, extreme care is taken to make it as accurate as possible.

This slide shows the usual path of traceability for an ordinary power sensor. At each level, at least one power standard is maintained for the frequency band of interest. That power sensor is periodically sent to the next higher level for re-calibration, then returned to its original level. Each level down the traceability path adds some measurement uncertainty. Rigorous measurement assurance procedures are used at the highest level as any error at that point must be included in the total uncertainty at every lower level, thus the cost of calibrations at national standard level tend to be the greatest, and reduces at every lower level.

To transfer power parameters such as calibration factor, effective efficiency and reflection coefficient, national standards organizations invariably use thermistor mounts, both coaxial and waveguide. By providing this traceable path to national standards, this makes thermistors the sensor of choice for most metrology applications.

Agenda

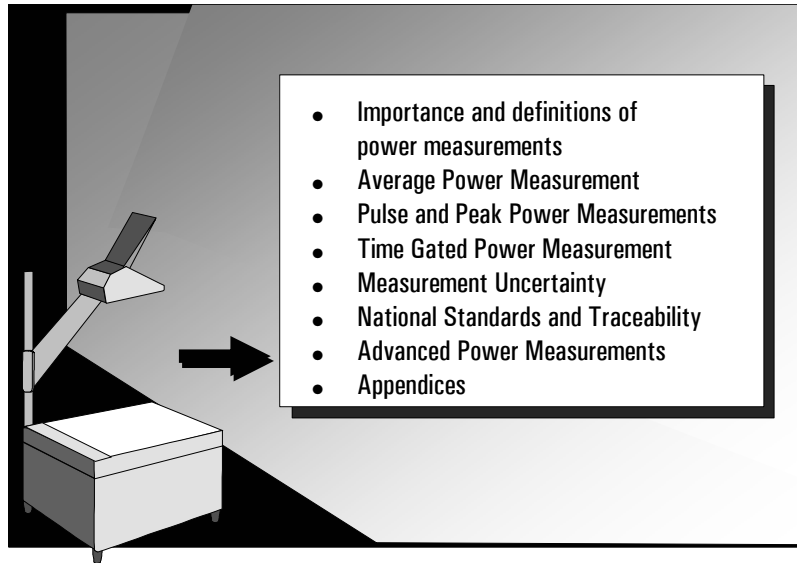

- Importance and definitions of power measurements
- Average Power Measurement
- Pulse and Peak Power Measurements
- Time Gated Power Measurement
- Measurement Uncertainty
- National Standards and Traceability
- Advanced Power Measurements
- Appendices

Power Measurement Basics



Agilent Technologies

www.agilent.com/find/backtobasics

Slide 43

Modern communications systems are placing an increasing demand on RF design and manufacturing engineers. Finished systems and component parts are increasingly tested using the same types of complex signals as their target application, and tested to ensure compliance to exacting international standards. As a consequence, the measurement role of the power meter has changed. Today, there is a demand for sophisticated in-box and PC-based advanced power measurements..

Advanced Power Measurements

- Trace display (pulse profile)
- Marker measurements and display analysis

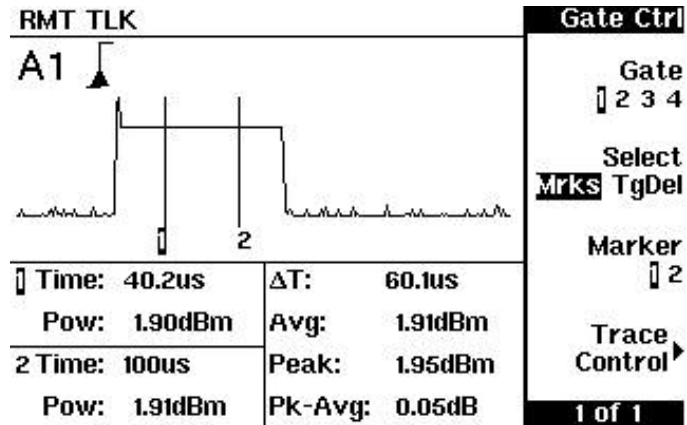

Agilent EPM-P power meter trace display and analysis screen

Power Measurement Basics



Agilent Technologies

www.agilent.com/find/backtobasics

Slide 44

The power meter display shows Agilent's response for making in-box measurements with the EPM-P series power meters, which is to provide a graphical trace setup and analysis screen. In this example, a pulse is shown with the variable markers 1 and 2 providing the instantaneous power and time relative to the trigger event. The right side of the analysis screen shows the delta time, delta average, delta peak and delta peak-to-average power ratio with respect to markers 1 and 2.

Advanced Power Measurements

- New *analyzer* features and measurements in PC or laptop environment



Agilent EPM-P Analyzer software

Power Measurement Basics



Agilent Technologies

www.agilent.com/find/backtobasics

Slide 45

To provide extensive power measurements, Agilent has adopted to provide advanced power measurements in a PC environment, thus providing a larger and more friendly user interface than possible with the smaller power meter front panel and display size. The “Agilent EPM-P Analyzer” software operates via the GPIB and provides the statistical, power, frequency and time measurements that are required for CDMA and TDMA signals.

Advanced Power Measurements

- Statistical Analysis:

- Cumulative Distribution Function (CDF)
- Complementary Cumulative Distribution Function (CCDF or 1-CDF)
- Probability Density Function (PDF)

Y axis is the percent time the signal power is at OR ABOVE the power specified by the X axis.

Example: For this CCDF curve, for 0.3% time the signal power is at or above 8 dB peak-to-average ratio

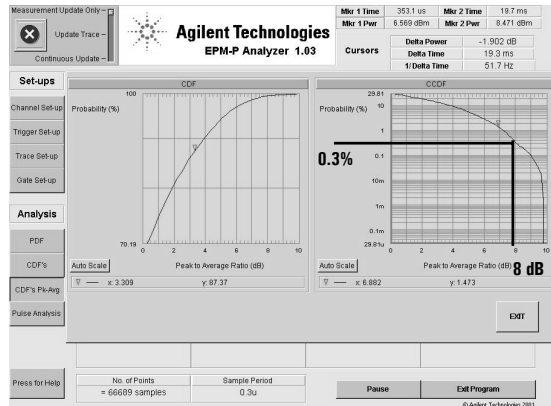

Power Measurement Basics



Agilent Technologies

www.agilent.com/find/backtobasics

Slide 46

CCDF curves, that's the complementary cumulative distribution function, are probably the most important of the statistical features supplied by the EPM-P analyzer software. They can be used for many applications. Perhaps the most important is to completely and without ambiguity specify the power characteristics of the signals that will be amplified, mixed and decoded in communication systems.

For CDMA signals, the statistical analysis of the power distribution can reveal important information to help optimize system design. For example, analyzing statistical data can reveal how a system or device, such as a power amplifier may be distorting the signal that it is transmitting. Comparison of the CCDF plots from an amplifier at differing average power levels validates the linearity and reveals the potential introduction of data errors that can be caused by signal compression.

In this slide, you can see that the X-axis is scaled in peak-to-average ratio or put in another way, dB above the signal average power. The Y-axis is also log scaled, this is to obtain better resolution of the lower probability events. For this CCDF curve, and shown in red, the signal spends 0.3% of its time at or above the average power plus 8 dBs.

Advanced Power Measurements

- **Pulse Analysis:**

- **Power *:**
Pulse Top, Pulse Base,
Distal, Mesial, Proximal, Peak,
Average, Peak/Average Ratio,
Burst Average and Duty Cycle

- **Time and Frequency:**
Rise Time, Fall Time, Pulse
Repetition Frequency (PRF),
Pulse Repetition Interval (PRI),
Pulse Width and Off Time

* IEEE pulse definitions and standards for video parameters applied to microwave pulse envelopes. ANSI/IEEE Std. 194-1977

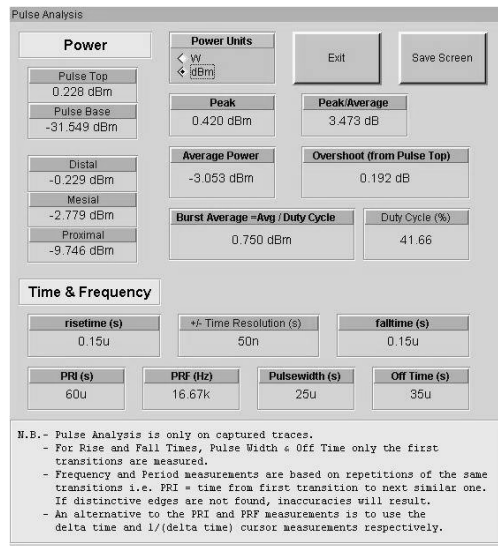

Power Measurement Basics



Agilent Technologies

www.agilent.com/find/backtobasics

Slide 47

The Pulse Analysis menu of the EPM-P analyzer software computes the numerous power, time and frequency parameters shown on the slide. The notes at the bottom of the pulse analysis are very informative about how the measurements are determined. For example, the pulse analysis is determined by the captured trace – by that we mean, what you see on the screen. Also, the rise and fall times are measured on the first transitions of the captured trace. So if you are level triggering, it is good practice to add in a negative time delay in order to see the complete first pulse rise time.

Some of the terms measured on the pulse analysis display may be unfamiliar to you. One reason that pulsed power is difficult to measure is that the waveform envelopes under test need many different parameters to characterize the power flow. With the 1990 introduction of the 8990 peak power analyzer, Agilent chose to extend the older IEEE definitions of video pulse characteristics into the RF and microwave domain. The standard shown here was originally a video pulse standard, the ANSI/IEEE standard 194-1977. For measurements of pulse parameters such as rise time or overshoot to be meaningful, the points on the waveform that are used in the measurement must be defined unambiguously. To achieve this, all the time parameters are measured between specific amplitude points on the pulse, and all the amplitude points are referenced to the two levels named pulse top and pulse base. For complete pulse power definitions, you can refer to Application Note 64-1C on the web:

<http://www.agilent.com/find/powermeters>

Agenda

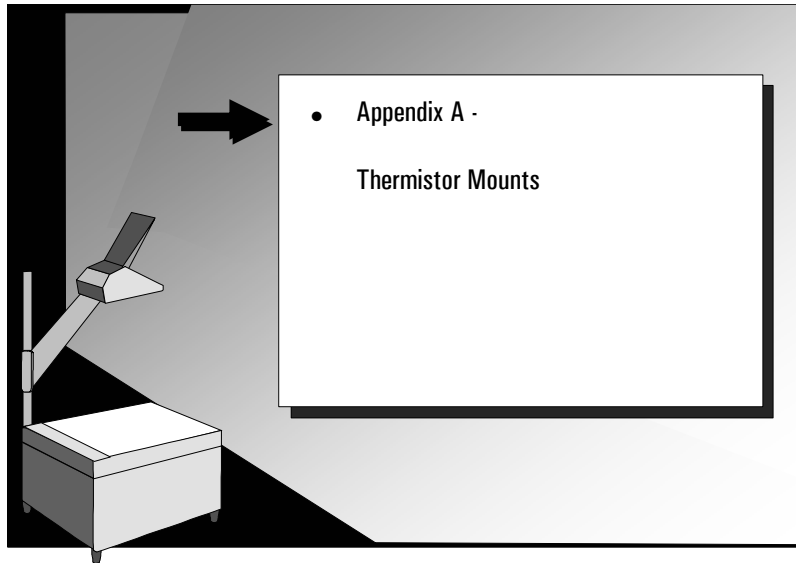

- Appendix A -
Thermistor Mounts



Thermistors

Characteristic curves of a typical thermistor element

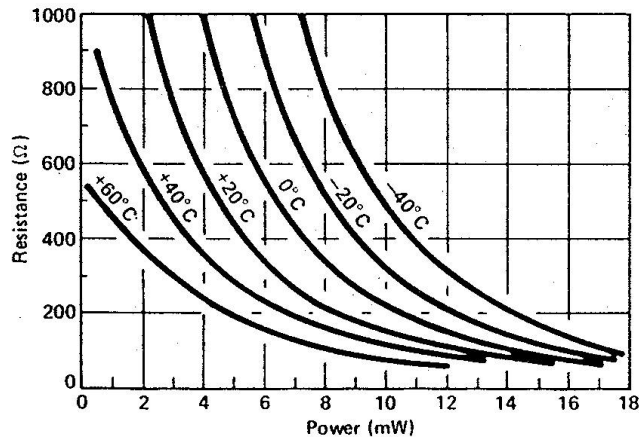

Power Measurement Basics



Agilent Technologies

www.agilent.com/find/backtobasics

Slide 49

Bolometers, in general, operate by changing resistance due to a change in temperature. A thermistor is a type of power sensor classified as a bolometer. A thermistor is a semiconductor which changes resistance due to a change in temperature resulting from incident RF power being dissipated in the element. A small bead of metallic oxides typically 0.4 mm in diameter with 0.03 mm wire leads comprises the actual thermistor elements.

The resistance versus power correlation of a thermistor is highly nonlinear and this correlation varies significantly from one thermistor to the next. To depend on the precise quantitative shape of such curves would result in difficult measurements. Instead, the thermistor is incorporated into a bridge circuit.

Thermistors

A self-balancing bridge containing a thermistor

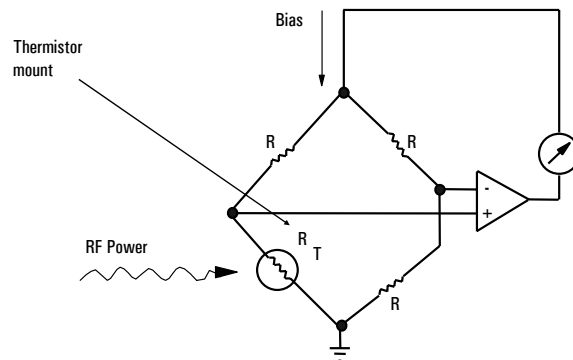

Power Measurement Basics



Agilent Technologies

www.agilent.com/find/backtobasics

Slide 50

We know that when a simple Wheatstone bridge is balanced, meaning both sides of the bridge are the same, there is no voltage across the bridge and the inputs of the amplifier are essentially equal. The bridge is balanced when there is no RF power incident on the thermistor. As RF power is applied to the thermistor, the thermistor is warmed and its resistance decreases. This change in resistance unbalances the bridge and produces a differential input to the amplifier. The amplifier, being in a feedback loop, automatically decreases the DC bias to the bridge just enough to allow the thermistor to cool back down, increase resistance, and bring the bridge back into balance. The decrease in DC power to the thermistor is equal to the increase in RF power incident upon the thermistor. A meter measures the amount of power that the amplifier must decrease to re-balance the bridge and this decrease in power is related to the increase in RF power dissipated in the thermistor element. The technique is known as DC substitution because we are indirectly measuring RF power by a direct measurement of DC power. This measurement, which requires no external reference source, is said to be "closed loop".

The 478A and 8478B coaxial, and the 486A waveguide thermistor sensors operate in the above fashion.

The main problem with a simple, self-balancing bridge, is that the thermistor resistance also changes as the ambient temperature changes. Simply touching a thermistor, for example, would warm the element, change the resistance, and be detected erroneously as a change in RF power. To correct for this, thermistor sensors (like the sensors listed above), add a second thermistor for sensing ambient temperature.

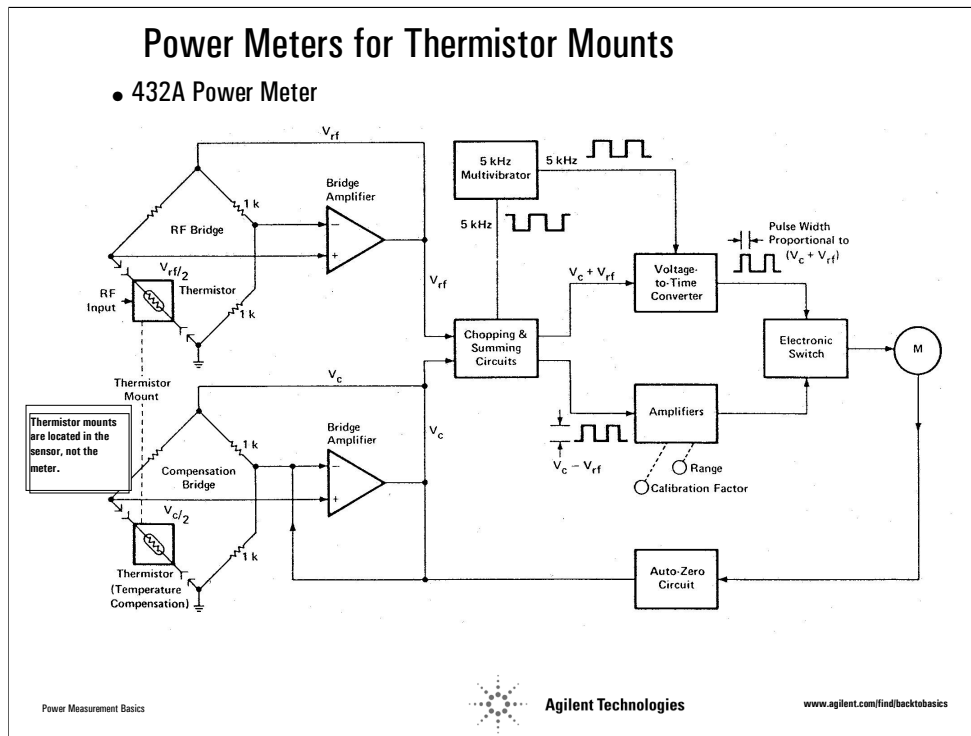

Slide 51

Meters that work with temperature compensated thermistor-mount sensors have two self-balancing bridges. The first bridge, the RF bridge, adjusts to changes in RF power, and a second bridge, the compensating bridge, compensates for changes in ambient temperature.

The power meter is initially zero-set with no applied RF power. If ambient temperature variations change the thermistor resistance after zero-setting, the bridge circuits each respond by applying the same new voltage to balance the bridges. If RF power is applied to the detecting thermistor, the RF bridge corrects for the change in resistance as was shown in the previous slide.

The 432A thermistor-based sensors contain two self-balancing thermistor bridges. The logic section and the auto-zero circuitry is contained in the 432A power meter. The RF bridge, which contains the detecting thermistor, automatically varies the DC voltage to balance the bridge due to changes in ambient temperature AND RF power. The compensating bridge, containing the compensating thermistor, balances the bridge by automatically varying the DC voltage to account for changes in the ambient temperature.

The 432A Power Meter uses DC power to maintain balance in both bridges in the thermistor. It has the added convenience of an automatic zero set, eliminating the need for the operator to precisely re-set zero for each range. The 432A features an instrumentation accuracy of one percent. It also provides the ability to externally measure the internal bridge voltages with precision digital DC voltmeters. This reduces the instrumentation uncertainty to 0.2 percent and is described in the operating manual for the 432A

Agenda

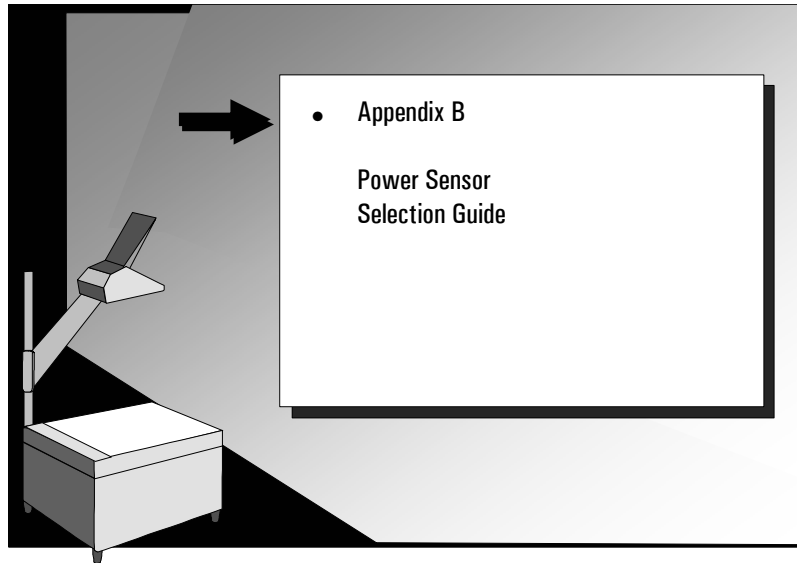

Power Measurement Basics



Agilent Technologies

www.agilent.com/find/backtobasics

Slide 52

When it comes to power sensor selection, Agilent Technologies offers you the widest range of power measurement solutions with over 30 power sensors in the 8480 and E-series.

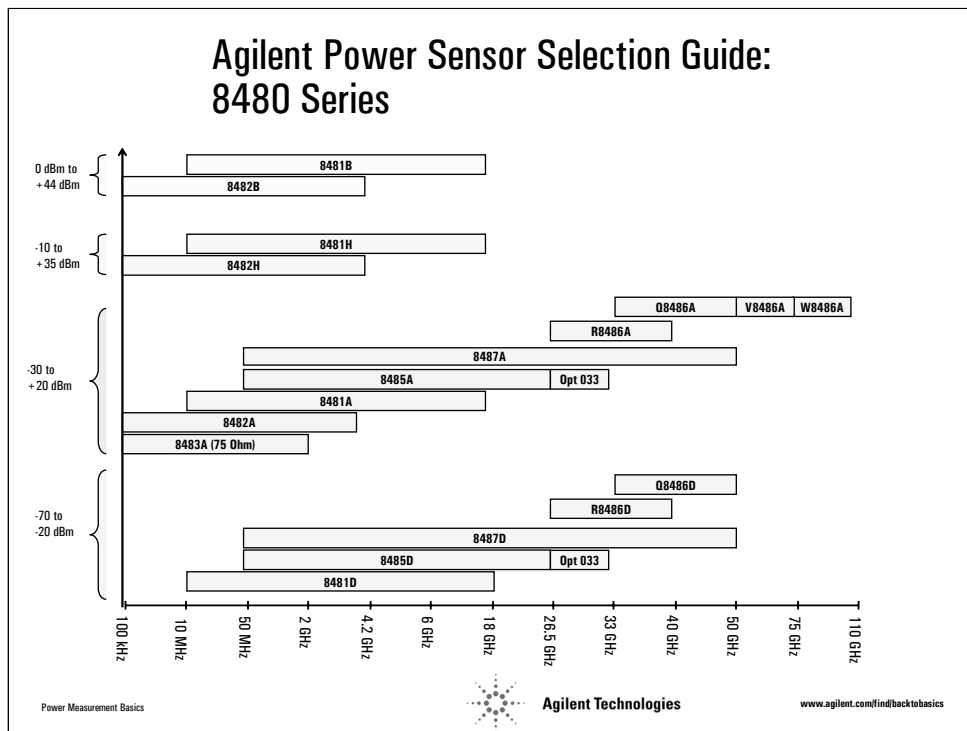

Slide 53

The traditional family of eighteen 8480 series power sensors provide a power, from -70 to +44 dBm, and frequency range from 100 kHz to 110 GHz. The 8480 series sensors comprise thermocouple and diode technologies. Thermocouple sensors cover the higher power levels, greater than -30 dBm, and have either an 'A', 'B' or 'H' suffix. The 848xD sensors are high sensitivity diode sensors covering the range -70 to -20 dBm. The odd sensors out from this convention are the 'V' and 'W' waveguide sensors, the V8486A and W8486A which are diode based. A 40 dB attenuator offsets their power range and thus designates them in the 'A' power range (-30 to +20 dBm).

The high power 848xB sensors are ideal for transmitter test, and can handle pulses up to 500 Watts peak. The 848xB sensors are 848xA sensors, combined with high power attenuators. The 848xH sensors can handle up to +35 dBm of average power. These sensors incorporate the basic 848xA design, along with an additional 20 dB attenuator. The 848xA sensors are the most commonly used power sensors, covering -30 to +20 dBm of power range.

A range of waveguide sensor are available with 'R', 'O', 'V' and 'W' prefixes, covering the frequency range 26.5 GHz to 110 GHz. All the other 8480 series sensors are coaxial.

Agilent Power Sensor Selection Guide: E-Series Wide Dynamic Range, CW and Average Sensors

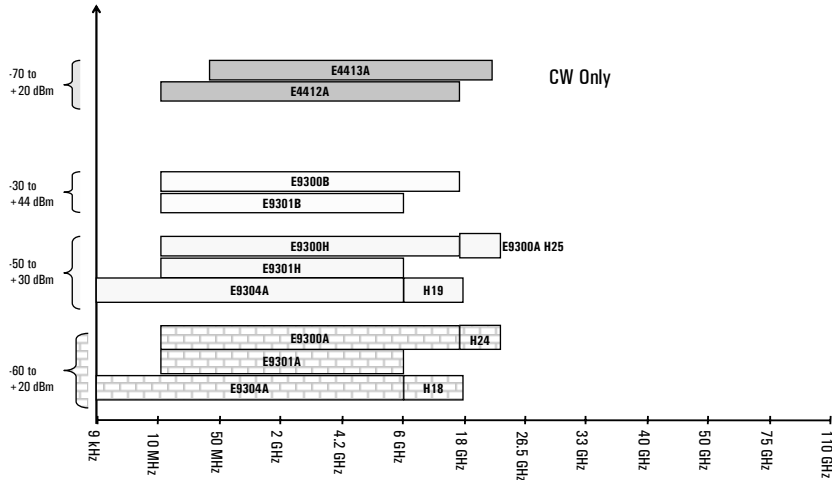

Power Measurement Basics



Agilent Technologies

www.agilent.com/find/backtobasics

Slide 54

The E-series diode power sensors are wide dynamic range (90 dB maximum) and have their calibration factors, linearity and temperature compensation data stored in EEPROM.

The E4412A and E4413A are our 90 dB dynamic range power sensors and they cover from -70dBm to +20dBm, and up to 26.5GHz. These sensors are continuous wave (CW) sensors only, and should not be used to measure the average power of modulated signals.

The E9300 power sensors can be used for modulated signals, multi-tone and CW signals. This family of sensors cover the frequency range from 9 kHz to 18GHz, with special options to 24 GHz.

The E930XB sensors can handle up to +44 dBm (25 W) average power. These sensors incorporate the basic E9300 design, along with an additional 30 dB attenuator, and this has a slightly reduced dynamic range of 74dB.

The E930XH sensors can handle up to +30 dBm of average power. These sensors incorporate the basic E9300 design, along with an additional 10 dB attenuator and provide the full 80dB dynamic range.

Agilent Power Sensor Selection Guide: E-Series E9320 Peak and Average Sensors

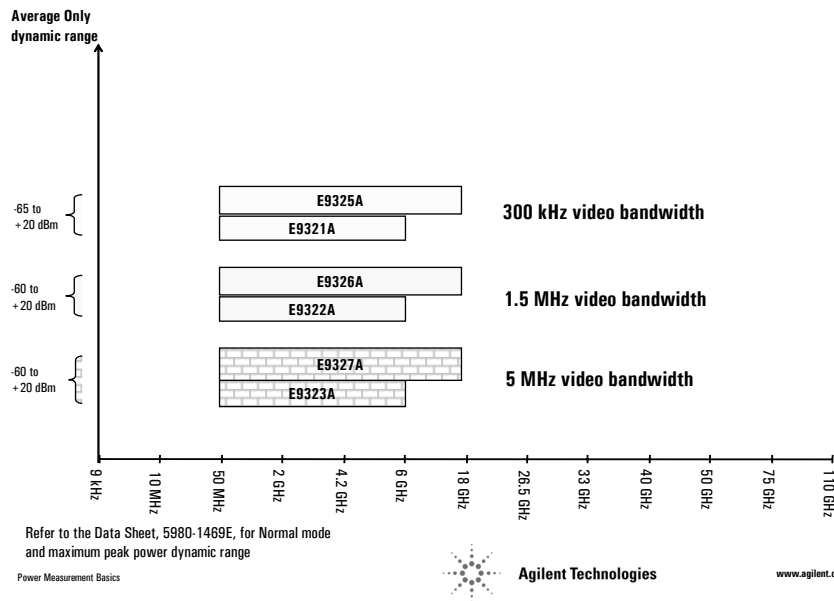

Slide 55

To make peak power measurements or to make time-gated measurements, the EPM-P power meter requires one of the E9320 family of power sensors. The E9320 family is the latest addition to the E-series power sensors which already include the E4412A and 13A, CW power sensors and the E9300 sensors for average power. There are six new power sensors with the model numbers shown here. Note that these power sensors only operate with the new EPM-P series power meters and require an E9288A-C sensor cable.

The power sensors differ in frequency range and also the bandwidth of the signal that they can measure. Taking frequency range first, there's two frequency ranges. All sensors start at 50 MHz and go to either 6 GHz or 18 GHz. The 6 GHz frequency range is aimed at customers working in the wireless communications market and provides a less expensive measurement solution.

The E9320 family of power sensors is also split by bandwidth. The bandwidth is referred to as the "video bandwidth," but can also be known by some customers as the "modulation bandwidth". This bandwidth refers to the bandwidth of the signal that is being measured and when selecting the required power sensor, there is a trade-off that needs to be made - the wider the video bandwidth, the smaller the dynamic range of the power sensor!

So what sensor is required for which application?

The 300 kHz video bandwidth sensors are ideal for GSM, iDEN and NADC applications. The 1.5 MHz video bandwidth sensors can be used for CDMAone and Bluetooth applications, while the 5 MHz video bandwidth sensor is targeted at W-CDMA and cdma2000 applications.